

0358R



**PIPER**

**CHEROKEE 140 B  
OWNER'S HANDBOOK**



# **CHEROKEE 140 B**

**PA-28-140**

## **Owner's Handbook**



**Piper Aircraft Corporation, Vero Beach, Florida  
U.S. A.**



## NOTICE

THIS HANDBOOK IS NOT DESIGNED, NOR CAN ANY HANDBOOK SERVE, AS A SUBSTITUTE FOR ADEQUATE AND COMPETENT FLIGHT INSTRUCTION, OR KNOWLEDGE OF THE CURRENT AIRWORTHINESS DIRECTIVES, THE APPLICABLE FEDERAL AIR REGULATIONS, AND ADVISORY CIRCULARS. IT IS NOT INTENDED TO BE A GUIDE OF BASIC FLIGHT INSTRUCTION, NOR A TRAINING MANUAL.

THE HANDBOOK IS DESIGNED:

1. TO HELP YOU OPERATE YOUR CHEROKEE WITH SAFETY AND CONFIDENCE.
2. TO MORE FULLY ACQUAINT YOU WITH THE BASIC PERFORMANCE AND HANDLING CHARACTERISTICS OF THE AIRPLANE.
3. TO MORE FULLY EXPLAIN YOUR CHEROKEE'S OPERATION THAN IS PERMISSIBLE TO SET FORTH IN THE AIRPLANE FLIGHT MANUAL.

IF THERE IS ANY INCONSISTENCY BETWEEN THIS HANDBOOK AND THE AIRPLANE FLIGHT MANUAL APPROVED BY THE F.A.A., THE FLIGHT MANUAL SHALL GOVERN.

---

Revised text and illustrations shall be indicated by a black vertical line in the margin opposite the change.

Additional copies of this manual, Part No. 753 787, may be obtained from your Piper Dealer.

---

Published by  
PUBLICATIONS DEPARTMENT  
Piper Aircraft Corporation  
753 787

Issued: September 1968

Revised: January 1973



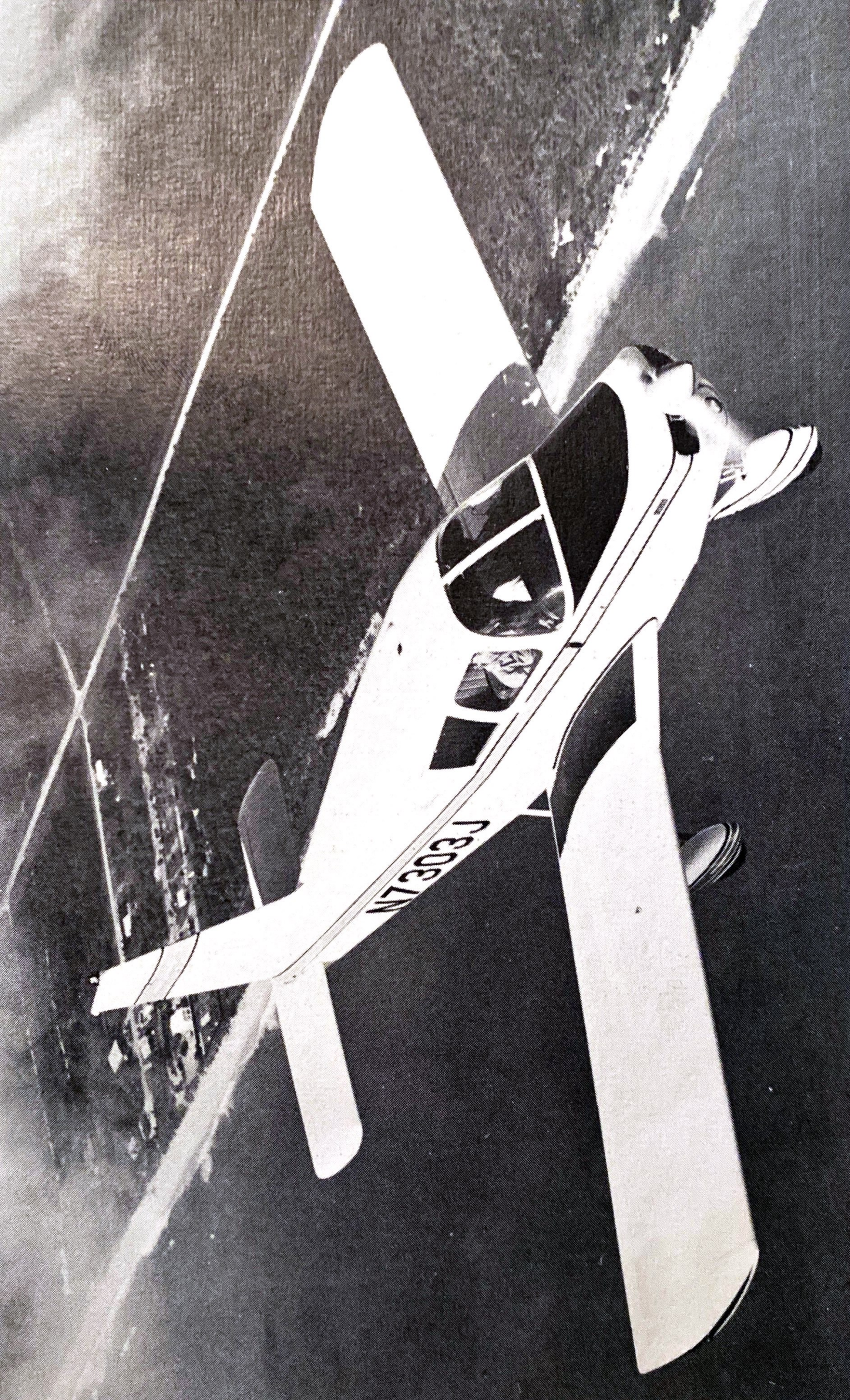



**SECTION I**  
**SPECIFICATIONS**

Performance . . . . .	1
Weights . . . . .	2
Power Plant . . . . .	2
Fuel and Oil . . . . .	3
Baggage . . . . .	3
Dimensions . . . . .	3
Landing Gear. . . . .	4



SECTION I  
SPECIFICATIONS

PERFORMANCE

The gross weight of 2150 pounds in the following performance charts applies to Serial Nos. 28-25001 and up.

Performance figures are for standard airplanes flown at gross weight under standard conditions at sea level, or stated altitude. Any deviation from standard equipment may result in changes in performance.

GROSS WEIGHT	2150
Take-off Run (ft) (flaps up)	800
Take-off Distance Over 50-ft Obstacle (ft) (flaps up)	1700
Best Rate of Climb Speed (mph)	85
Rate of Climb (ft per min)	660
Service Ceiling (ft)	14,300
Absolute Ceiling	16,800
Top Speed (mph)	139 (142*)
Cruising Speed (75% power, sea level) (mph)	121 (124*)
Cruising Speed (75% power, optimum altitude, mph)	132 (135*)
Instructional Power Cruise Speed (50% power, sea level)	100 (102*)
Fuel Consumption (gal per hr 75%)	8.4
Fuel Consumption (gal per hr 50%)	5.6

\* WITH FENDERS INSTALLED



## SPECIFICATIONS (cont):

## PERFORMANCE

<b>GROSS WEIGHT</b>	2150
Cruising Range (75% power, sea level, mi)	495 (710**)
Cruising Range (75% power, optimum altitude)	540 (780**)
Optimum Cruising Range (55% power, optimum altitude)	670 (930**)
Instructional Power Cruising Range (50% power, sea level)	630 (880**)
Stalling Speed (flaps down, mph)	55
Landing Roll (flaps down, ft)	535

## WEIGHTS

Gross Weight (lbs)	2150
Empty Weight (Standard) (lbs)	1230
USEFUL LOAD (Standard) (lbs)	920

## POWER PLANT

Engine - Lycoming	O-320-E2A
Rated Horsepower and Speed (rpm)	150 at 2700
Bore (inches)	5.125
Stroke (inches)	3.875
Displacement (cubic inches)	319.8
Compression Ratio	7:1
Dry Weight (pounds)	272

\*\* WITH RESERVE FUEL (50 GAL)



SPECIFICATIONS (cont):

POWER PLANT

Oil Sump Capacity (qts)	8
Propeller (Sensenich)	M74DM

FUEL AND OIL

Fuel Capacity (U.S. gal) Standard	36
Fuel Capacity (U.S. gal) Reserve	50
Oil Capacity (qts)	8
Fuel, Aviation Grade (minimum octane)	80/87

BAGGAGE

Maximum Baggage (lbs)	200***
Baggage Space (cubic ft)	22

DIMENSIONS

Wing Span (ft)	30
Wing Area (sq ft)	160
Wing Loading (lbs per sq ft)	13.4
Length (ft)	23.3
Height (ft)	7.3
Power Loading (lbs per hp)	14.3

\*\*\* EXCEPT WHEN FAMILY SEATS AND SAFETY BELTS ARE INSTALLED, 340 LBS IS PERMITTED.



## SPECIFICATIONS (cont):

## LANDING GEAR

Wheel Base (ft)		6.2
Wheel Tread (ft)		10.0
Tire Pressure (lbs)	Nose	24
	Main	24



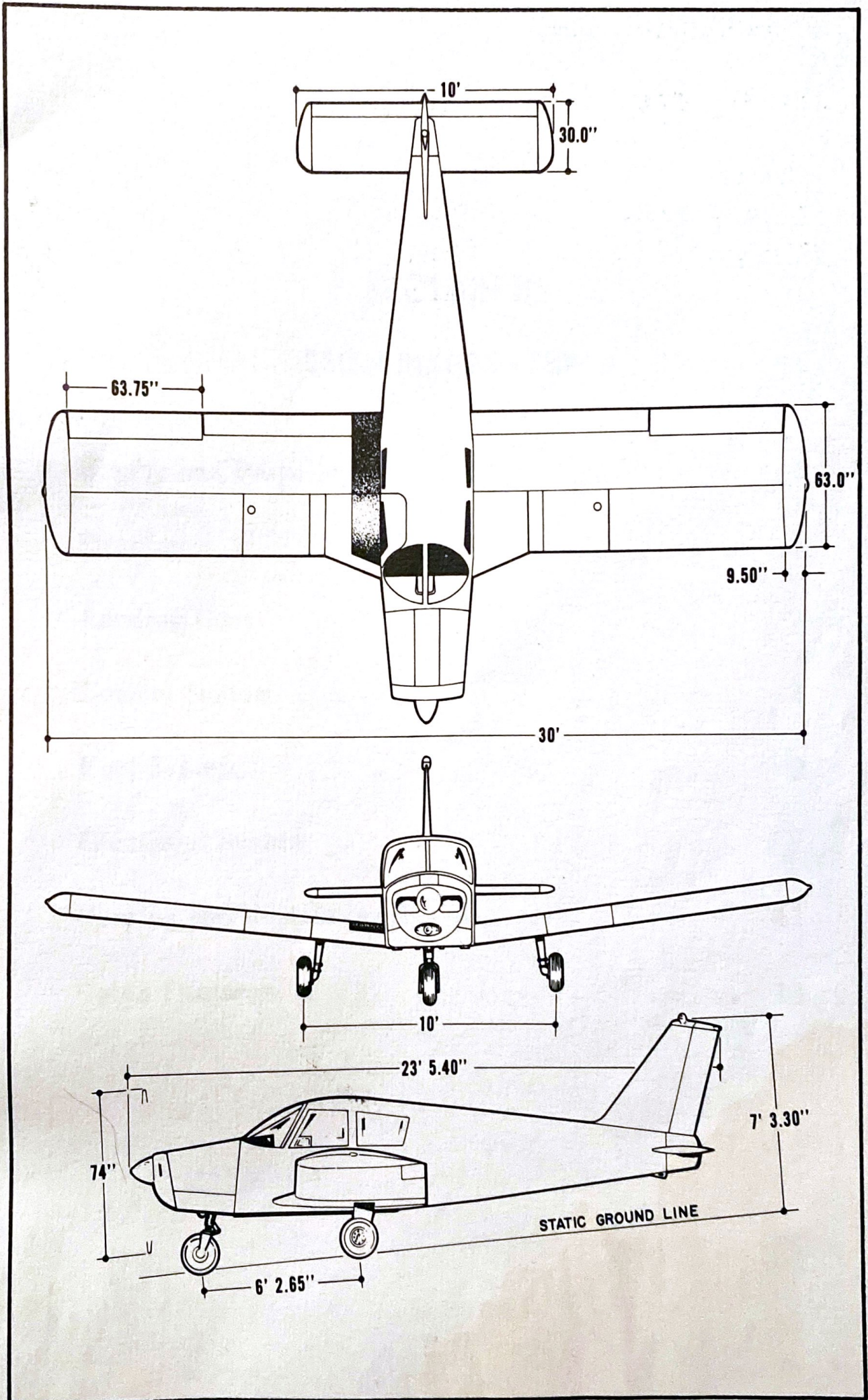



## SECTION II

### DESIGN INFORMATION

Engine and Propeller . . . . .	6
Structures . . . . .	7
Landing Gear . . . . .	7
Control System . . . . .	8
Fuel System . . . . .	9
Electrical System . . . . .	9
Heating and Ventilating System . . . . .	11
Cabin Features . . . . .	13



## SECTION II

## DESIGN INFORMATION

## ENGINE AND PROPELLER

The Lycoming O-320-E2A engine installed in the Cherokee PA-28-140 is rated at 140 horsepower at 2450 rpm or 150 horsepower at 2700 rpm. This engine has a compression ratio of 7 to 1 and requires 80/87 minimum octane fuel. The engine is equipped with direct drive or optional geared drive starter. A 60 ampere alternator, dual magnetos, vacuum pump drive, diaphragm type fuel pump and a float carburetor.

Exhaust gases are carried through a system constructed of heavy gauge stainless steel which incorporates a heater shroud, to provide cabin heat, defrosting and carburetor deicing.

The propeller used on the PA-28-140 is a Sensenich M74DM fixed-pitch aluminum alloy unit. Its diameter is 74 inches with a standard pitch of 58 inches. All performance figures are based on the standard 58 inch pitch propeller.

Cowling on the Cherokee is designed to cool the engine in all normal flight conditions, including protracted climb, without the use of cowl flaps or cooling flanges.

The throttle quadrant is in the lower center of the instrument panel and contains the throttle and mixture control. A friction lock on the right side of the quadrant prevents creeping of the controls. To the right of the quadrant is the carburetor heat control that provides maximum carburetor heat when fully ON. Avoid prolonged ground operation with carburetor heat ON as the air is unfiltered. Air passes through a highly efficient dry type filter when the carburetor heat is OFF.



## STRUCTURES

All structures are of aluminum alloy construction and are designed to ultimate load factors well in excess of normal requirements. All exterior surfaces are primed with etching primer and painted with acrylic lacquer.

The wings are attached to each side of the fuselage by inserting the butt ends of the respective main spars into a spar box carry through which is an integral part of the fuselage structure, providing, in effect, a continuous main spar with splices at each side of the fuselage. There are also fore and aft attachments at the rear spar and at an auxiliary front spar.

The wing airfoil section is a laminar flow type, NACA65<sub>2</sub>-415 with the maximum thickness about 40% aft of the leading edge. This permits the main spar carry through structure to be located under the rear seat providing unobstructed cabin floor space ahead of the rear seat.

## LANDING GEAR

The three landing gears use a Cleveland 6.00 x 6 wheel, the main wheels being provided with brake drums and Cleveland single disc hydraulic brake assemblies. The nose wheel and the main gear both use 6.00 x 6 four ply tires. All the tires have tubes.

The nose gear is steerable through a .44° arc by use of the rudder pedals. A spring device is incorporated in the rudder pedal torque tube assembly to aid in rudder centering and to provide rudder trim. The nose gear steering mechanism also incorporates a hydraulic shimmy dampener.

The oleo struts are of the air-oil type with normal extension being 3.25 inches for the nose gear and 4.50 inches for the main gear under normal static (empty weight of airplane plus full fuel



and oil) load.

The brakes are actuated by a hand lever and a master cylinder which is located below and near the center of the instrument panel. The toe brakes and the hand lever have their own brake cylinders but they both use a common reservoir. The parking brake is incorporated in the lever brake and is operated by pulling back on the lever and depressing the knob attached to the top of the handle. To release the parking brake, pull back on the brake lever to disengage the catch mechanism; then allow the handle to swing forward.

## CONTROL SYSTEM

Dual controls are provided as standard equipment with a cable system used between the controls and the surfaces. The horizontal tail is of the all movable slab type, with an anti-servo tab acting as a longitudinal trim tab. It is actuated by a control on the cabin ceiling. The stabilator provides extra stability and control with less size, drag, and weight than conventional tail surfaces. The differential action of the ailerons tends to eliminate adverse yaw in turning maneuvers and reduces the amount of coordination required in normal turns.

The flaps are manually operated, balanced for light operating forces and spring loaded to turn to the up position. A past-center lock incorporated in the actuating linkage holds the flap when it is in the up position so that it may be used as a step on the right side. The flap will not support a step load except when in the full up position, so it must be completely retracted when used as a step. The flaps have three extended positions, 10, 25 and 40 degrees.



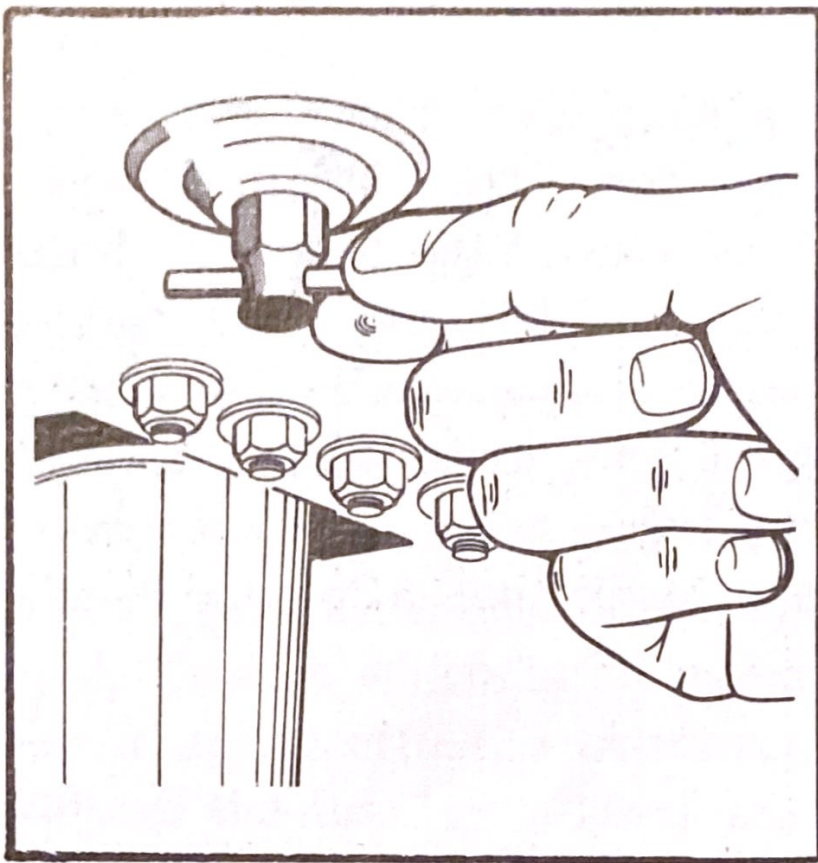

**Fuel Strainer**

## FUEL SYSTEM

Fuel is stored in two twenty-five gallon tanks which are secured to the leading edge structure of each wing by screws and nut plates to allow easy removal for service or inspection.

The standard quantity of fuel is 36 gallons for the Cherokee 140 "B". To obtain the standard quantity of fuel, fill

the tanks to the bottom of the filler neck indicator.

An auxiliary electric fuel pump is provided for use in case of failure of the engine driven pump. The electric pump should be on for all take-offs and landings and when switching tanks.

The fuel strainer is equipped with a quick drain and is located on the front lower left corner of the firewall. This strainer should be drained regularly to check for water or sediment accumulation. To drain the lines from the tanks, the tank selector valve must be switched to each tank in turn, with the electric pump on, and the gascolator drain valve opened. Each tank has an individual quick drain located at the bottom, inboard, rear corner.

Fuel quantity and pressure are indicated on gauges located in the engine gauge cluster on the left side of the instrument panel.

## ELECTRICAL SYSTEM

The electrical system includes a 12 volt 60 ampere alternator, battery, voltage regulator, overvoltage relay, and master



switch relay. The battery and master switch relay are located beneath the baggage compartment floor. Access for service or inspection is obtained by raising the hinged floor panel. The regulator and overvoltage relay are located on the forward left side of the fuselage behind the instrument panel.

Electrical switches are located on the right center instrument panel, and the circuit breakers are located on the lower right instrument panel. A rheostat switch on the right side of the switch panel controls the navigation lights and the intensity of the instrument panel light.

Standard electrical accessories include starter, electric fuel pump, stall warning indicator, cigar lighter, and ammeter. Navigation lights, anti-collision light, landing light and instrument panel lighting are offered as optional accessories.

Circuit provisions are made to handle a complete complement of communications and navigational equipment.

The alternator system offers many advantages over the generator system. The main advantage is full electrical power output at much lower engine RPM and results in improved radio and electrical equipment operation. Since the alternator output is available all the time, the battery will be charging almost continuously. This will make cold weather starting easier.

In generator systems, the ammeter indicates battery discharge. In the Cherokee electrical system the ammeter displays in amperes the load placed on the alternator. With all electrical equipment except the master switch in the OFF position, the ammeter will indicate the amount of charging current demanded by the battery. As each item of electrical equipment is turned on, the current will increase to a total appearing on the ammeter. This total includes the battery. The maximum continuous load for night

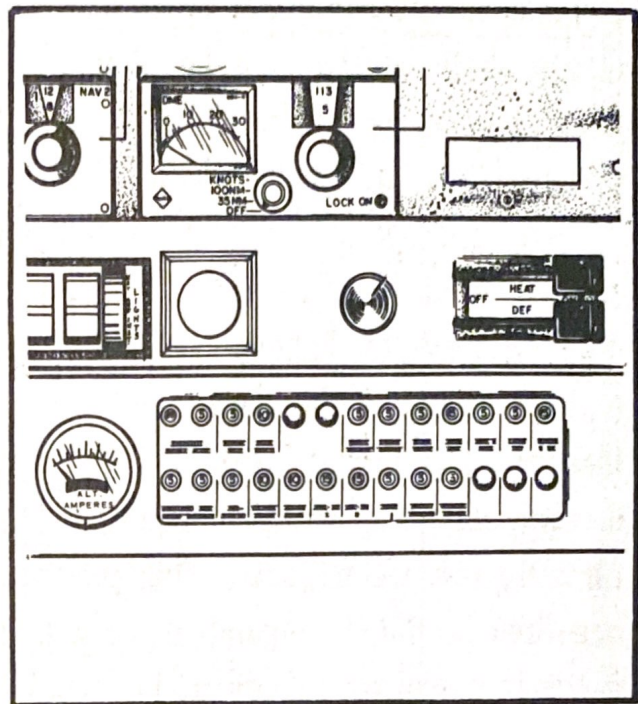

**Circuit Breaker Panel**



flight with radios on is about 30 amperes. This 30 ampere value plus approximately 2 amperes for a fully charged battery will appear continuously under these flight conditions.

The master switch is a split switch with the left half operating the master relay and the right half energizing the alternator. The switch is interlocked so that the alternator cannot be operated without the battery. For normal operation, be sure both halves are turned on. If no output is indicated on the ammeter, during flight, reduce the electrical load by turning off all unnecessary electrical equipment. Check both the 5 ampere field breaker and 60 ampere output breaker and reset if open. If neither circuit breaker is open, turn off the "ALT" switch for 30 seconds to reset the overvoltage relay. If ammeter continues to indicate no output, turn off the "ALT" switch, maintain minimum electrical load and terminate flight as soon as practical.

Maintenance on the alternator should prove to be a minor factor. Should service be required, contact the local Piper Dealer. Do not take off with a fully discharged battery as 3 volts are needed to excite the alternator.

## HEATING AND VENTILATING SYSTEM

Heat for the cabin interior and the defroster system is provided by a heater muff attached to the exhaust system. The amount of heat desired can be regulated with the controls located on the far right side of the instrument panel. If unusual odors are noticed, the heat should be shut off and the system inspected for leaks.

Fresh air inlets are located in the leading edge of the wing at the intersection of the tapered and straight sections. A large adjustable outlet is located on the side of the cabin near the floor at each seat location. Cabin air is exhausted through an outlet located below the rear seat floor panel.



# CHEROKEE 140 B

## Cabin Heat, Defroster, Fresh Air

- 1. Fresh Air Control
- 2. Defroster Control
- 3. Heater Control
- 4. Defroster Air Outlet
- 5. Fresh Air Inlet
- 6. Cabin Exhaust Outlet

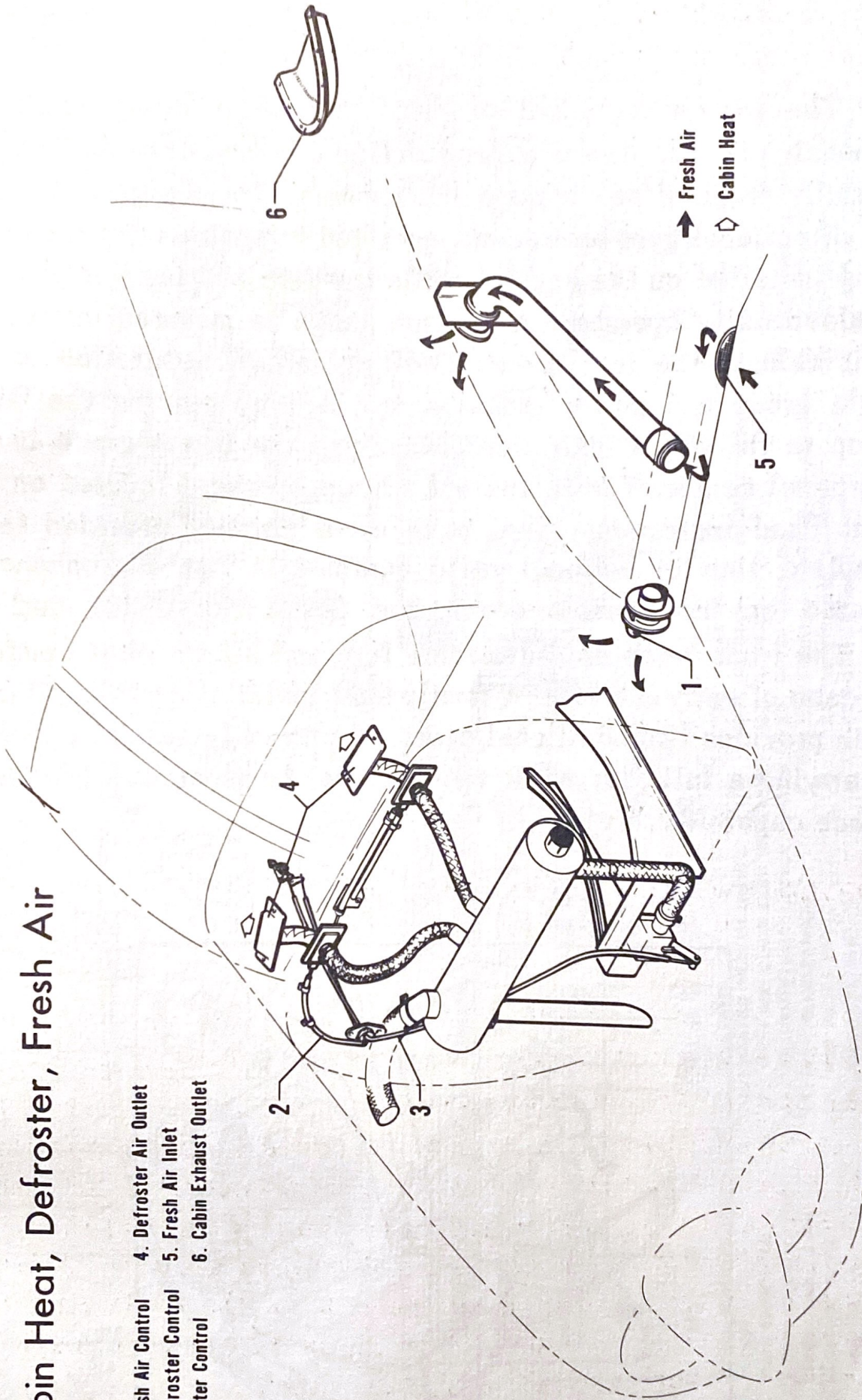



## CABIN FEATURES

The instrument panel of the Cherokee is designed to accommodate the customary advanced flight instruments and all the normally required power plant instruments. The artificial horizon and directional gyro are vacuum operated through use of a vacuum pump installed on the engine, while the turn and bank instrument is electrically operated. A vacuum gauge is mounted on the far right side of the instrument panel. A natural separation of the flight group and power group is provided by placing the flight group in the upper instrument panel and the power group in the sub-panel center. The radios and circuit breakers located on the right hand instrument panel have extra circuits provided for a complete line of optional radio equipment. The microphone is located on the console cover from Serial No. 25801 and up.

The front seats are adjustable fore and aft for pilot comfort and ease of entry and exit. A family seat installation is available which provides two additional seats. Each family seat is capable of carrying a full size adult which gives the Cherokee 140 "B", 4-place capability.

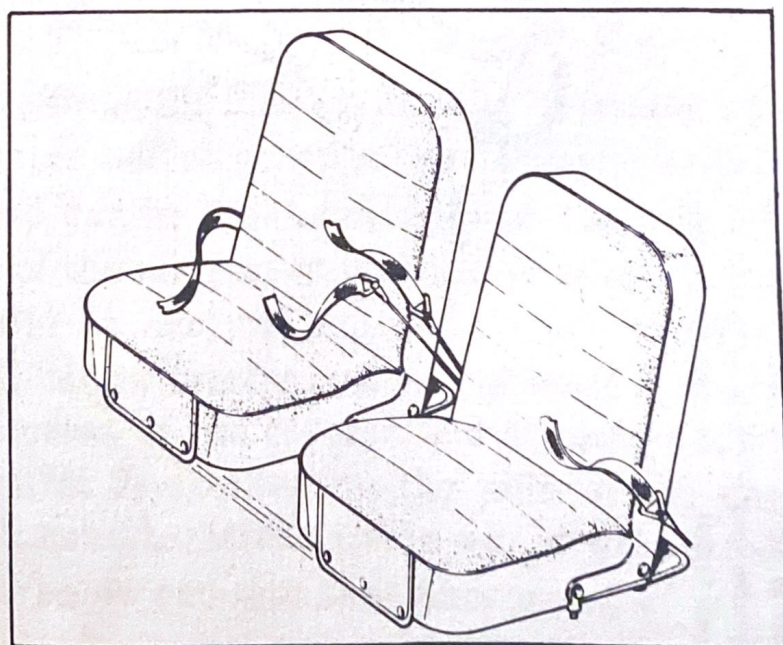

FAMILY SEATS



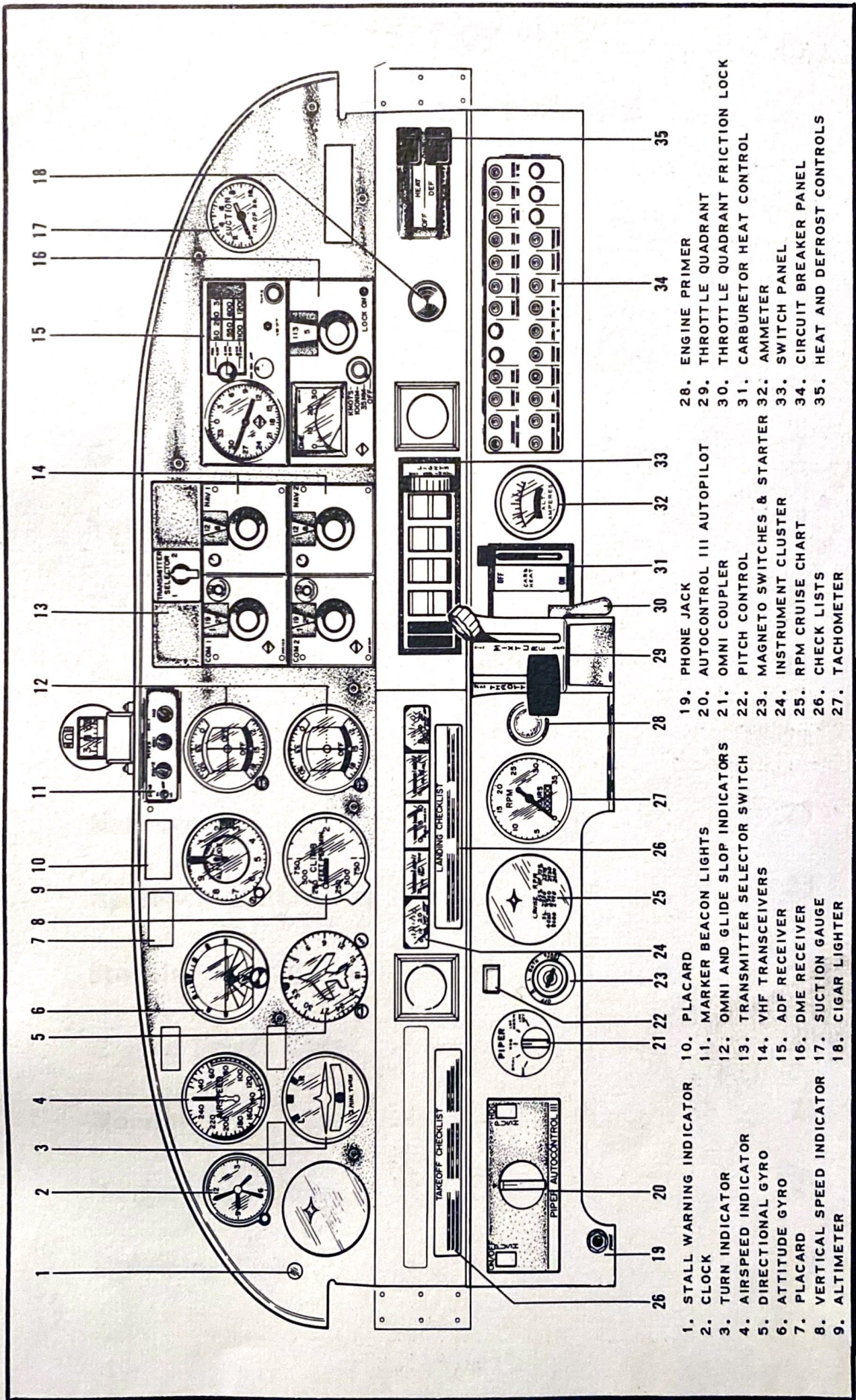

- 1. STALL WARNING INDICATOR
- 2. CLOCK
- 3. TURN INDICATOR
- 4. AIRSPEED INDICATOR
- 5. DIRECTIONAL GYRO
- 6. ATTITUDE GYRO
- 7. PLACARD
- 8. VERTICAL SPEED INDICATOR
- 9. ALTIMETER
- 10. PLACARD
- 11. MARKER BEACON LIGHTS
- 12. OMNI AND GLIDE SLOP INDICATORS
- 13. TRANSMITTER SELECTOR SWITCH
- 14. VHF TRANSEIVERS
- 15. ADF RECEIVER
- 16. DME RECEIVER
- 17. SUCTION GAUGE
- 18. CIGAR LIGHTER
- 19. PHONE JACK
- 20. AUTOCONTROL III AUTOPILOT
- 21. OMNI COUPLER
- 22. PITCH CONTROL
- 23. MAGNETO SWITCHES & STARTER
- 24. INSTRUMENT CLUSTER
- 25. RPM CRUISE CHART
- 26. CHECK LISTS
- 27. TACHOMETER
- 28. ENGINE PRIMER
- 29. THROTTLE QUADRANT
- 30. THROTTLE QUADRANT FRICTION LOCK
- 31. CARBURETOR HEAT CONTROL
- 32. AMMETER
- 33. SWITCH PANEL
- 34. CIRCUIT BREAKER PANEL
- 35. HEAT AND DEFROST CONTROLS



**SECTION III**  
**OPERATING INSTRUCTIONS**

Preflight . . . . .	15
Starting Engine . . . . .	16
Warm-Up . . . . .	18
Ground Check . . . . .	19
Take-Off . . . . .	19
Climb . . . . .	21
Stalls . . . . .	21
Cruising . . . . .	22
Maneuvers . . . . .	23
Approach and Landing . . . . .	23
Stopping Engine . . . . .	24
Engine Power Loss . . . . .	24
Mooring . . . . .	25
Weight and Balance . . . . .	25
Operating Tips . . . . .	25



SECTION III  
OPERATING INSTRUCTIONS

PREFLIGHT

The airplane should be given a thorough visual inspection prior to each flight. Particular attention should be given to the following items:

1. a. Master switch ON.
- b. Check fuel quantity indicators (two tanks).
- c. Master switch and ignition OFF.

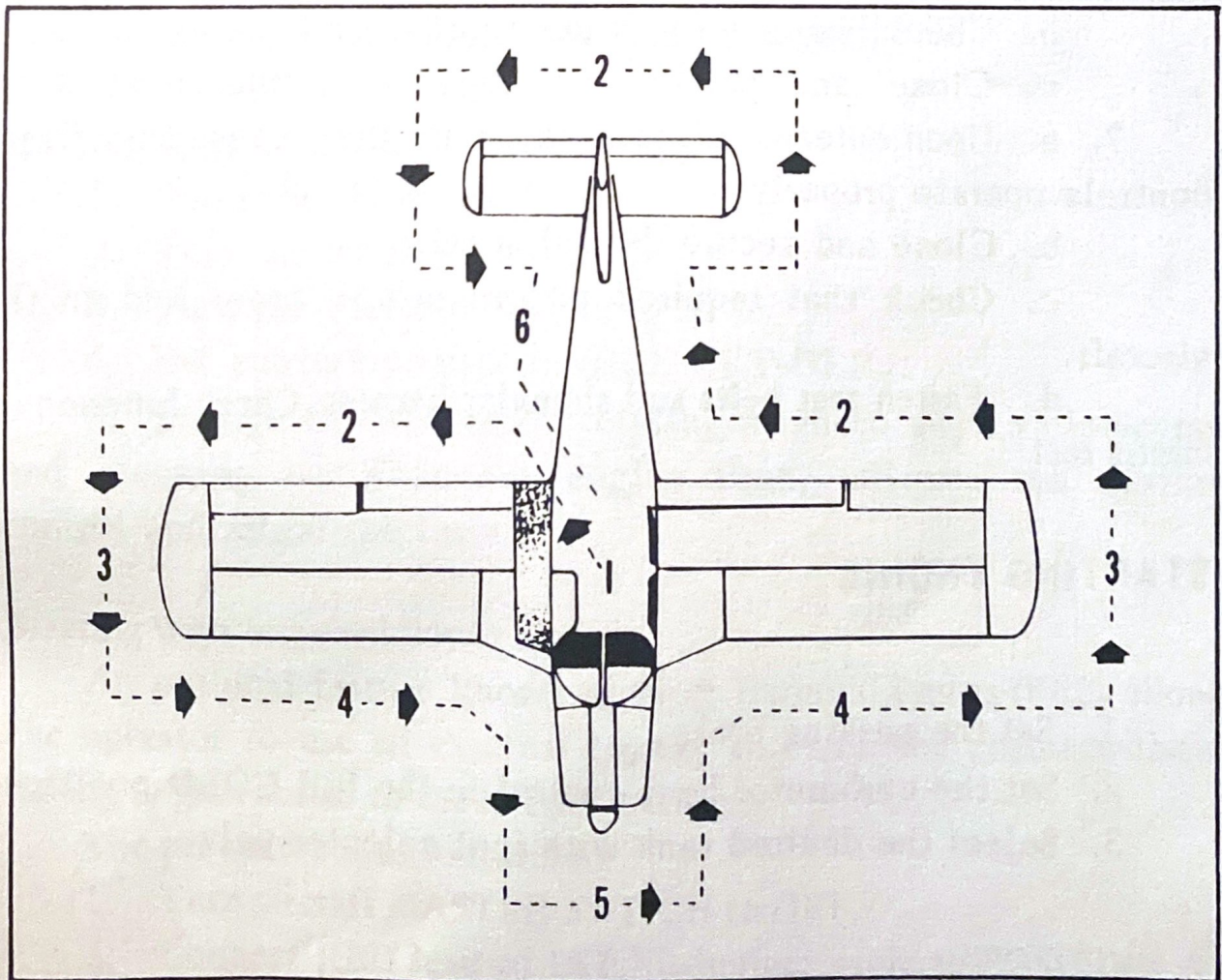



2. a. Check for external damage, operational interference of control surfaces or hinges.  
b. Insure that wings and control surfaces are free of snow, ice or frost.
3. a. Visually check fuel supply, secure caps.  
b. Drain fuel tank sumps.  
c. Check that fuel system vents are open.
4. a. Check landing gear shock struts for proper inflation.  
b. Check tires for cuts, wear and proper inflation.
5. a. Inspect windshield for cleanliness.  
b. Check the propeller and spinner for defects or nicks.  
c. Check for obvious fuel or oil leaks.  
d. Check oil level, 8 quarts maximum. (Insure dipstick is properly seated.)  
e. Inspect cowling and inspection covers for security.  
f. Check nose wheel tire for inflation, wear.  
g. Check nose wheel shock strut for proper inflation.  
h. Check for foreign matter in air inlets.
6. a. Stow tow bar and control locks, if used.  
b. Check baggage for proper storage and security.  
c. Close and secure the baggage compartment door.
7. a. Upon entering aircraft ascertain that all primary flight controls operate properly.  
b. Close and secure the cabin door.  
c. Check that required papers are in order and in the aircraft.  
d. Fasten seat belts and shoulder harness. Check function of inertia reel.

### STARTING ENGINE

1. Set the parking brake.
2. Set the carburetor heat control in the full COLD position.
3. Select the desired tank with fuel selector valve.



**Starting Engine When Cold:**

1. Open throttle approximately 1/4 inch.
2. Turn the master switch ON.
3. Turn the electric fuel pump ON.
4. Move the mixture control to FULL RICH.
5. Engage the starter by rotating magneto switch clockwise and pressing in.
6. When the engine fires, advance throttle to desired setting. If the engine does not fire within five to ten seconds, disengage starter and prime with one to three strokes of the priming pump. Repeat the starting procedure.

**Starting Engine When Hot:**

1. Open the throttle approximately 1/2 inch.
2. Turn the master switch ON.
3. Turn the electric fuel pump ON.
4. Put mixture control in IDLE CUT-OFF.
5. Engage the starter by rotating magneto switch clockwise and pressing in. When the engine fires, advance the mixture control and move the throttle to desired setting.

**Starting Engine When Flooded:**

1. Open the throttle full.
2. Turn the master switch ON.
3. Turn the electric fuel pump OFF.
4. Put mixture control in IDLE CUT-OFF.
5. Engage the starter by rotating magneto switch clockwise and pressing in. When the engine fires, advance the mixture control and retard the throttle.

**Starting With External Power Source:**

An optional feature known as Piper External Power (PEP) allows the operator to use an external battery to crank the engine without having to gain access to the aircraft battery.

The procedure is as follows:

1. Turn aircraft MASTER SWITCH to OFF.
2. Connect RED lead of PEP kit jumper cable to POSITIVE (+) terminal of external 12 volt battery and BLACK lead to NEGATIVE (-)



terminal.

3. Insert plug of jumper cable into socket located on aircraft fuselage.

4. Turn aircraft MASTER SWITCH to ON and proceed with NORMAL engine starting technique.

5. After engine has been started, turn MASTER SWITCH to OFF and remove jumper cable plug from aircraft.

6. Turn aircraft MASTER SWITCH to ON and check alternator ammeter for indication of output. DO NOT ATTEMPT FLIGHT IF THERE IS NO INDICATION OF ALTERNATOR OUTPUT.

When the engine is firing evenly, advance the throttle to 800 RPM. If oil pressure is not indicated within thirty seconds, stop the engine and determine the trouble. In cold weather it will take a few seconds longer to get an oil pressure indication. If the engine has failed to start, refer to the "Lycoming Operating Handbook, Engine Troubles and Their Remedies."

Starter manufacturers recommend that cranking periods be limited to thirty seconds with a two minute rest between cranking periods. Longer cranking periods will shorten the life of the starter.

## WARM-UP

As soon as the engine starts, the oil pressure should be checked. If no pressure is indicated within thirty seconds, stop the engine and determine the trouble. In cold weather it will take a few seconds longer to get an oil pressure indication. Warm-up the engine at 800 to 1200 RPM.

Take-off may be made as soon as ground check is completed, providing that the throttle may be opened fully without back firing or skipping, and without reduction in engine oil pressure.



**GROUND CHECK**

Check the magnetos at 1800 RPM by switching from Both to Right then back to Both before switching to Left. Differential drop should not exceed 50 RPM while the total drop on either magneto should not exceed 175 RPM.

Check vacuum gauge, indicator should read 5" Hg  $\pm$ .1" Hg at 2000 RPM.

Check both the oil temperature and pressure. The temperature may be low for some time if the engine is being run for the first of the day, but as long as the pressure is within limits the engine is ready for take-off.

Carburetor heat should also be checked prior to take-off to be sure that the control is operating properly and to clear any ice which may have formed during taxiing. Avoid prolonged ground operation with carburetor heat ON as the air is unfiltered.

The electric fuel pump should be turned off momentarily during ground check to make sure that the engine driven pump is operating. The electric fuel pump should be on during take-off to prevent loss of power should the engine driven pump fail. The engine is warm enough for take-off when the throttle can be opened without the engine faltering.

**TAKE-OFF**

Just before take-off the following items should be checked:

- |                          |                               |
|--------------------------|-------------------------------|
| 1. Fuel on proper tank   | 6. Quadrant friction knob set |
| 2. Electric fuel pump ON | 7. Flaps set                  |
| 3. Engine gauges checked | 8. Trim tab set               |
| 4. Carburetor heat OFF   | 9. Controls free              |
| 5. Mixture RICH          | 10. Door latched              |
|                          | 11. Fasten belts/harness      |



In the conventional take-off procedure set the trim control slightly aft of neutral. Allow the airplane to accelerate to 50 to 60 miles per hour, then ease back on the wheel enough to let the airplane fly itself from the ground. Premature or excessive raising of the nose will result in a delayed take-off. After take-off let the aircraft accelerate to the desired climb speed by lowering the nose slightly.

#### Short Field, Obstacle Clearance:

Lower the flaps to 25° (second notch), accelerate to 55-60 miles per hour and ease back on the control wheel to rotate. After breaking ground, accelerate to the best angle of climb speed, 74 miles per hour. Slowly retract the flaps when the obstacle has been cleared and continue climb at 85 miles per hour.

#### Short Field, No Obstacles:

Lower the flaps to 25° (second notch) accelerate to 55-60 miles per hour. Ease back on the control wheel to rotate and accelerate to best rate of climb speed, 85 miles per hour. Slowly retract the flaps while climbing out.

#### Soft Field, No Obstacle:

Lower the flaps to 25° (second notch), accelerate aircraft and pull nose gear from the ground as soon as possible, lift off at lowest possible airspeed. Accelerate just above the ground to best rate of climb speed, 85 miles per hour. Climb out while slowly retracting the flaps.

#### Soft Field, Obstacle Clearance:

Lower flaps to 25° (second notch), accelerate aircraft, pull nose gear off as soon as possible and lift off at lowest possible airspeed. Accelerate just above the ground to best angle of climb speed, 74 miles per hour to climb past obstacle clearance height, continue climb while accelerating to best rate of climb speed, 85 miles per hour and slowly retract the flaps.



**CLIMB**

The best rate of climb airspeed at gross weight is 85 miles per hour while the best angle of climb airspeed is 74 miles per hour. At lighter than gross weight these speeds are reduced. The recommended enroute climbing speed of 100 miles per hour provides increased visibility over the nose. Shallow turns of a few degrees will also aid forward visibility during climb out.

**STALLS**

Stall characteristics of the Cherokee are conventional. Visual stall warning is provided by a red light located on the left side of the instrument panel which is turned on automatically between 5 and 10 miles per hour above stall speed. Gross weight stalling speed with power off and full flaps is 55 miles per hour at 2150 pounds. With flaps up this speed is increased 9 miles per hour.

Intentional spins are prohibited in the normal category airplane. Lazy eights and chandelles may be performed in the normal category provided a 60° angle of bank and/or a 30° angle of pitch is not exceeded. For approved maneuvers and entry speeds refer to the Flight Manual.

STALL SPEED TABLE		
Angle of Bank	Flaps 40°	Flaps Retracted
0°	55 MPH	64 MPH
20°	57 MPH	66 MPH
40°	63 MPH	73 MPH
60°	78 MPH	91 MPH
Power Off – Gross Weight 2150 lbs.		



## CRUISING

The cruising speed is determined by many factors including power setting, altitude, temperature, loading and equipment installed on the airplane.

The normal cruising power is 75% of the rated horsepower of the engine. True airspeeds which may be obtained at various altitudes and power settings can be determined from the charts in Section IV of this handbook.

Use of the mixture control in cruising flight reduces fuel consumption significantly, especially at higher altitudes. The mixture should be leaned during cruising operation above 5000 feet altitude and at pilot's discretion at lower altitudes when 75% power or less is being used. If any doubt exists as to the amount of power being used, the mixture should be in the FULL RICH position for all operations under 5000 feet.

To lean the mixture, pull the mixture control until the engine becomes rough, indicating that the lean mixture limit has been reached in the leaner cylinders. Then enrich the mixture by pushing the control towards the instrument panel until engine operation becomes smooth.

The continuous use of carburetor heat during cruising flight decreases engine efficiency. Unless icing conditions in the carburetor are severe, do not cruise with the heat on. Apply full carburetor heat slowly and only for a few seconds at intervals determined by icing severity.

In order to keep the airplane in best lateral trim during cruising flight, the fuel should be used alternately from each main tank. It is recommended that one main tank be used for one hour after take-off; the other main tank used until nearly exhausted, then return to the first main tank.



## MANEUVERS

The airplane is approved for certain aerobatic maneuvers, provided it is loaded within the approved weight and center of gravity limits. (See Airplane Flight Manual) The maneuvers are spins, steep turns, lazy eights and chandelles.

## APPROACH AND LANDING

Landing check list:

1. Fuel on proper tank
2. Electric fuel pump on
3. Mixture set
4. Flaps set (115 MPH MAX)
5. Fasten belts/harness

The airplane should be trimmed to an approach speed of about 85 miles per hour with flaps up. The flaps can be lowered at speeds up to 115 miles per hour, approach speed is reduced 3 miles per hour for each notch of flaps used. Carburetor heat should not be applied unless there is an indication of carburetor icing, since the use of carburetor heat causes a reduction in power which may be critical in case of a go-around. Full throttle operation with carburetor heat on is likely to cause detonation.

The amount of flap used during landings and the speed of the aircraft at contact with the runway should be varied according to the landing surface and existing conditions, both windwise and loadwise. It is generally good practice to contact the ground at the minimum possible safe speed consistent with existing conditions.

Normally, the best technique for short and slow landings is to use full flap and enough power to maintain the desired airspeed and approach flight path. Mixture should be full rich, fuel on the fullest tank, carburetor heat off, and electric fuel pump on.



Reduce the speed during the flareout and contact the ground close to the stalling speed (55 to 65 MPH). After ground contact hold the nose wheel off as long as possible. As the airplane slows down, drop the nose and apply the brakes. There will be less chance of skidding the tires if the flaps are retracted before applying the brakes. Braking is most effective when back pressure is applied to the control wheel, putting most of the aircraft weight on the main wheels. In high wind conditions, particularly in strong crosswinds, it may be desirable to approach the ground at higher than normal speeds with partial or no flaps.

### STOPPING ENGINE

At the pilot's discretion, the flaps should be raised and the electric fuel pump turned off. After parking, the radios should be turned off and the engine stopped by pulling the mixture control to idle cut-off. The throttle should be left full aft to avoid engine vibration while stopping. Then the magneto and master switches should be turned off.

### ENGINE POWER LOSS

The most common cause of engine power loss is mismanagement of the fuel. Therefore, the first step to take after engine power loss is to move the fuel selector valve to the tank not being used. This will often keep the engine running even if there is no apparent reason for the engine to stop on the tank being used.



## MOORING

The Cherokee should be moved on the ground with the aid of the nose wheel tow bar provided with each plane and secured in the baggage compartment. Tie downs may be secured to rings provided under each wing, and to the tail skid. The aileron and stabilator control wheel shaft are secured by looping the seat belt through the control wheel and pulling it tight. The rudder is held in position by its connections to the nose wheel steering, and normally does not have to be secured. The flaps are locked when in the full up position, and should be left retracted.

## WEIGHT AND BALANCE

It is the responsibility of the owner and pilot to determine that the airplane remains within the allowable weight vs. center of gravity envelope while in flight. For weight and balance data see the Airplane Flight Manual and Weight and Balance Form supplied with each airplane.

## OPERATING TIPS

The following Operating Tips are of particular value in the operation of the Cherokee 140 "B".

1. Learn to trim for take-off so that only a very light back pressure on the wheel is required to lift the airplane off the ground.
2. The best speed for take-off is about 60 MPH under normal conditions. Trying to pull the airplane off the ground at too low an airspeed decreases the controllability of the airplane in event of engine failure.



3. Flaps may be lowered at airspeeds up to 115 MPH. To reduce flap operating loads, it is desirable to have the airplane at a slower speed before extending the flaps.

4. Before attempting to reset any circuit breaker, allow a two to five minute cooling off period.

5. Before starting the engine, check that all radio switches, light switches, and the pitot heat switch are in the off position so as not to create an overloaded condition when the starter is engaged.

6. The overvoltage relay is provided to protect the electronics equipment from a momentary overvoltage condition (approximately 16.5 volts and up), or a catastrophic regulator failure. In the event of a momentary condition, the relay will open and the ammeter will indicate "0" output from the alternator. The relay may be reset by switching the ALT switch to OFF for approximately one minute and then returning the ALT switch to ON. If after recycling the ALT switch the condition persists, the flight should be terminated as soon as practical, reduce the battery load to a minimum.

7. The vacuum gauge is provided to monitor the pressure available to assure the correct operating speed of the vacuum driven gyroscopic flight instruments, it also monitors the condition of the common air filter by measuring the flow of air thru the filter.

If the vacuum gauge registers lower than  $5'' \pm .10''$  Hg at 2000 RPM, the following items should be checked before flight:

- a. Common air filter, could be dirty or restricted.
- b. Vacuum lines could be collapsed or broken.
- c. Vacuum pump, worn.
- d. Vacuum regulator, not adjusted correctly. The pressure, even though set correctly, can read lower under two conditions: (1) Very high altitude, above 12000 feet, (2) Low engine RPM usually on approach or during training maneuvers. This is normal and should not be considered a malfunction.



## SECTION IV

### PERFORMANCE CHARTS

Altitude Conversion Chart . . . . .	28
Take-off Distance vs Density Altitude. . . . .	29
Rate of Climb vs Density Altitude . . . . .	30
True Airspeed vs Density Altitude . . . . .	31
Range vs Density Altitude . . . . .	32
Power vs Density Altitude . . . . .	33
Landing Distance vs Density Altitude. . . . .	34
Glide Distance vs Attitude . . . . .	35



# PA-28-140 PIPER CHEROKEE

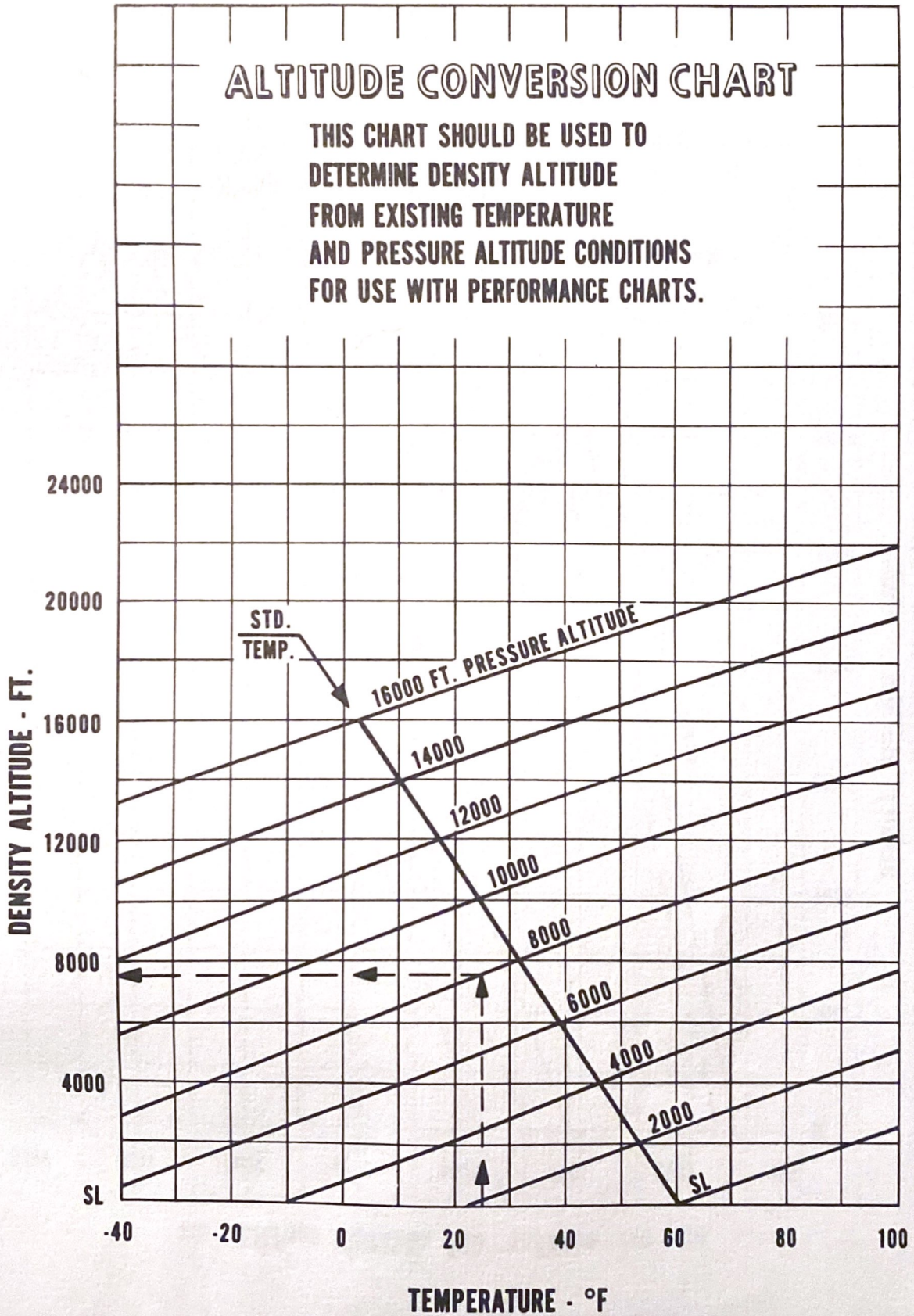



# PIPER CHEROKEE PA-28-140

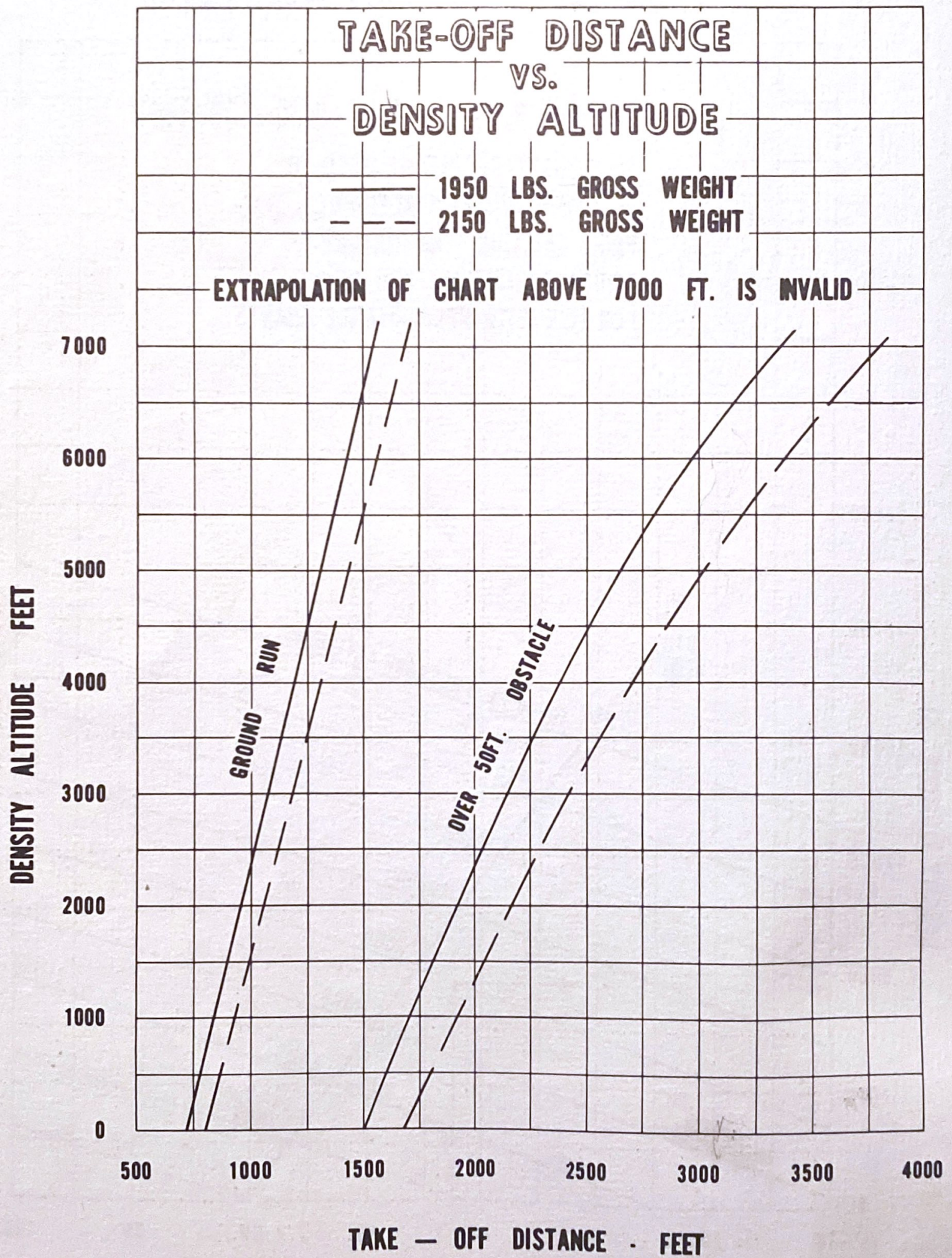



# PA-28-140 PIPER CHEROKEE

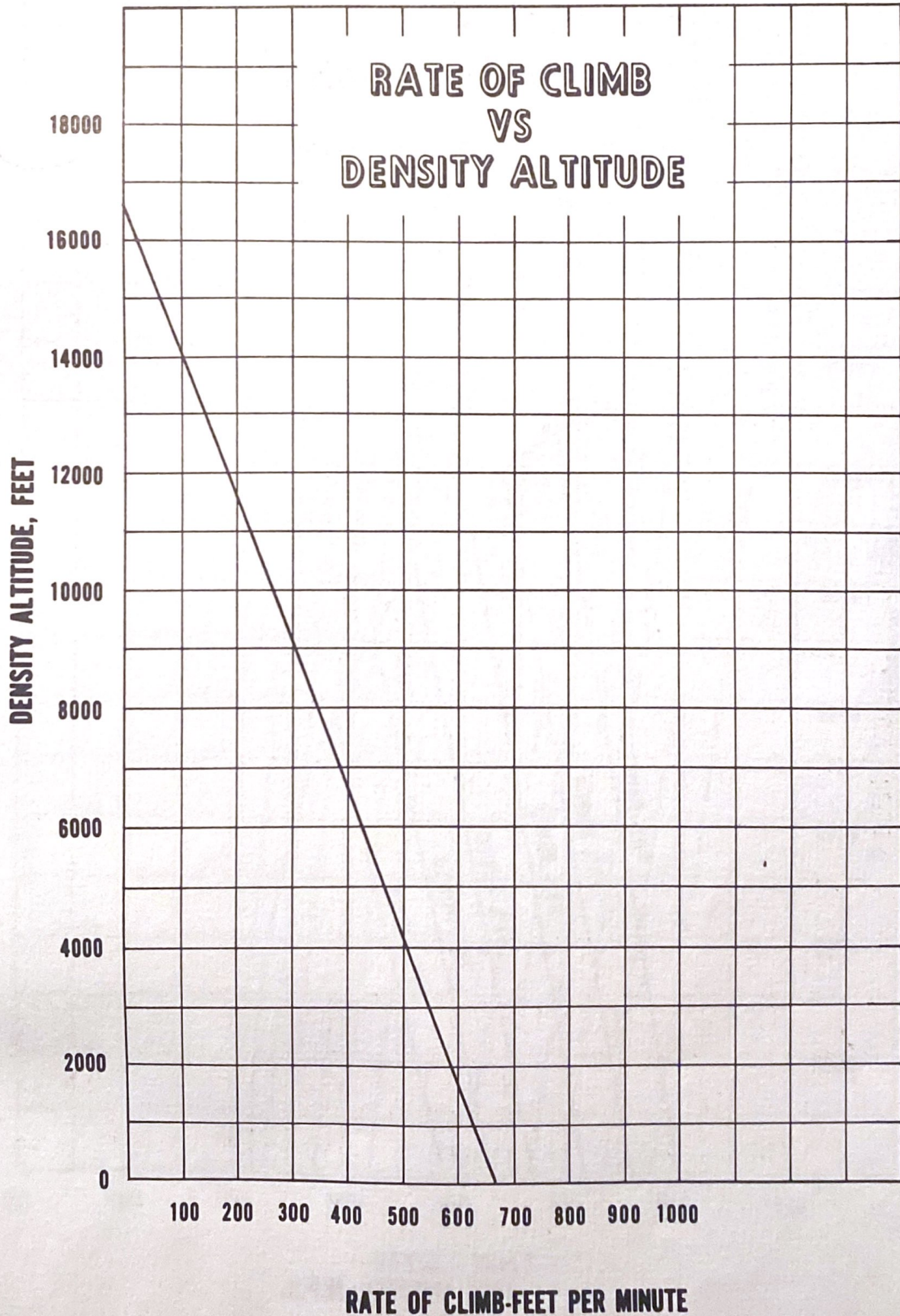



# PA-28-140 PIPER CHEROKEE

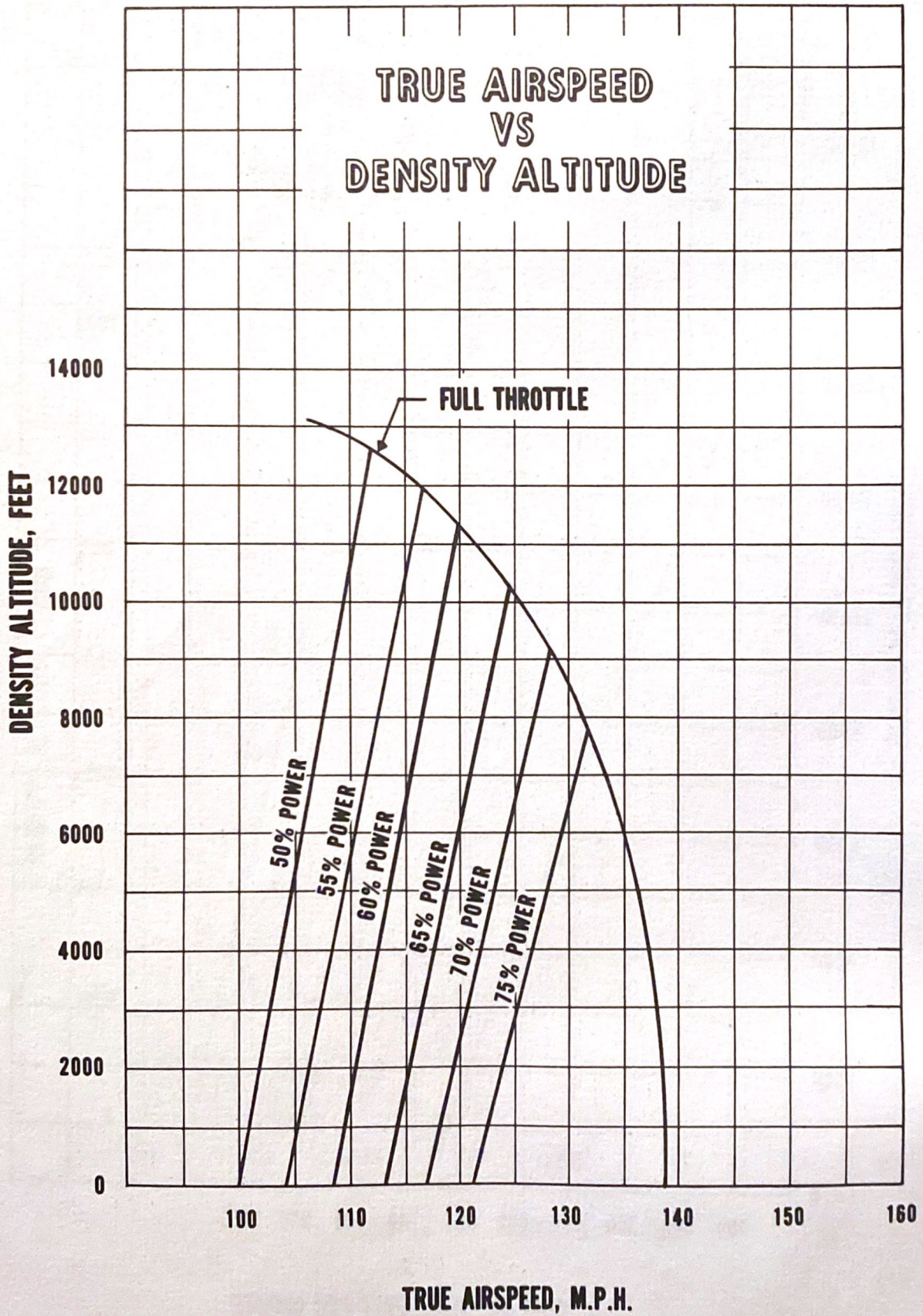



# PA-28-140 PIPER CHEROKEE

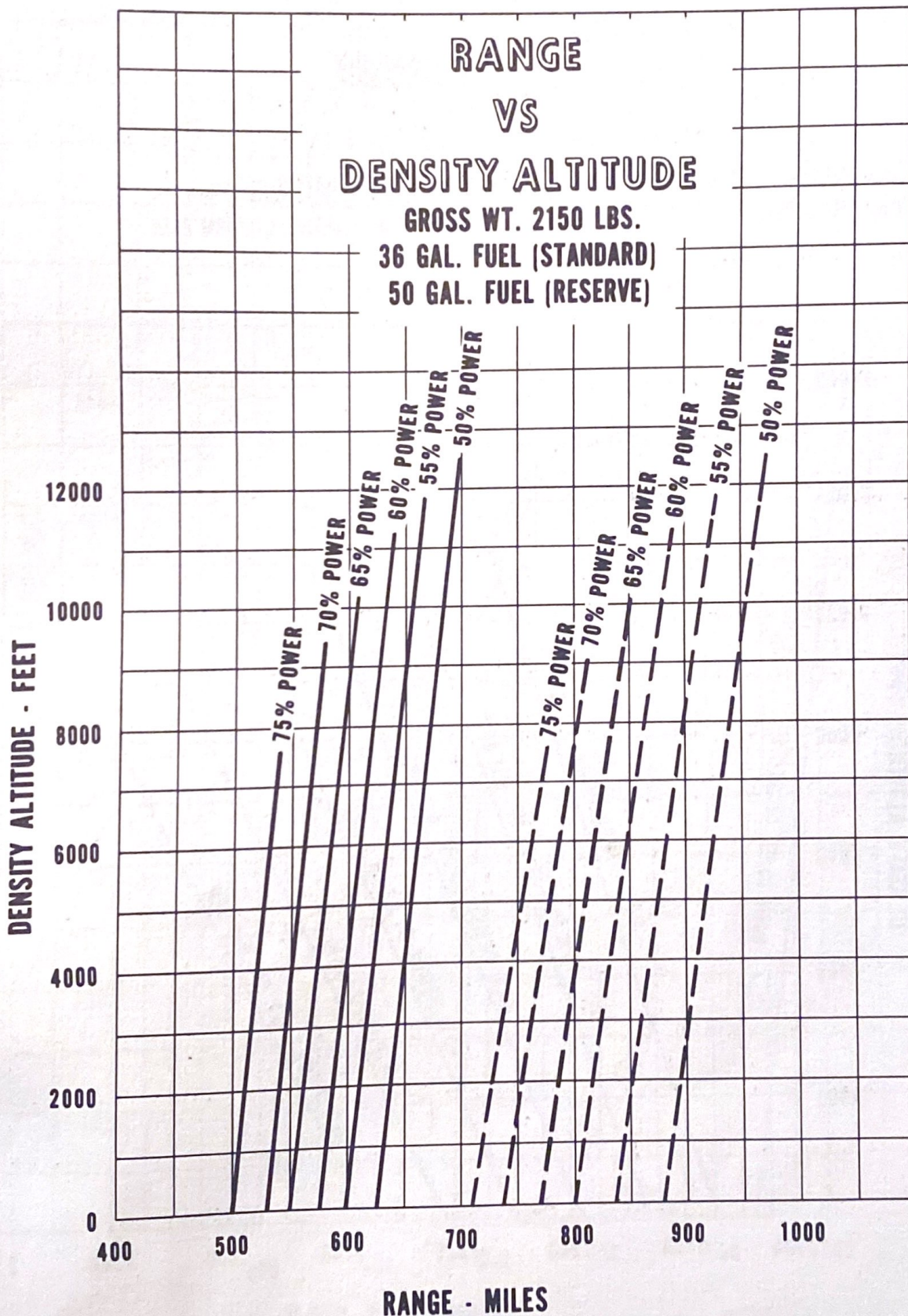



# PA-28-140 PIPER CHEROKEE

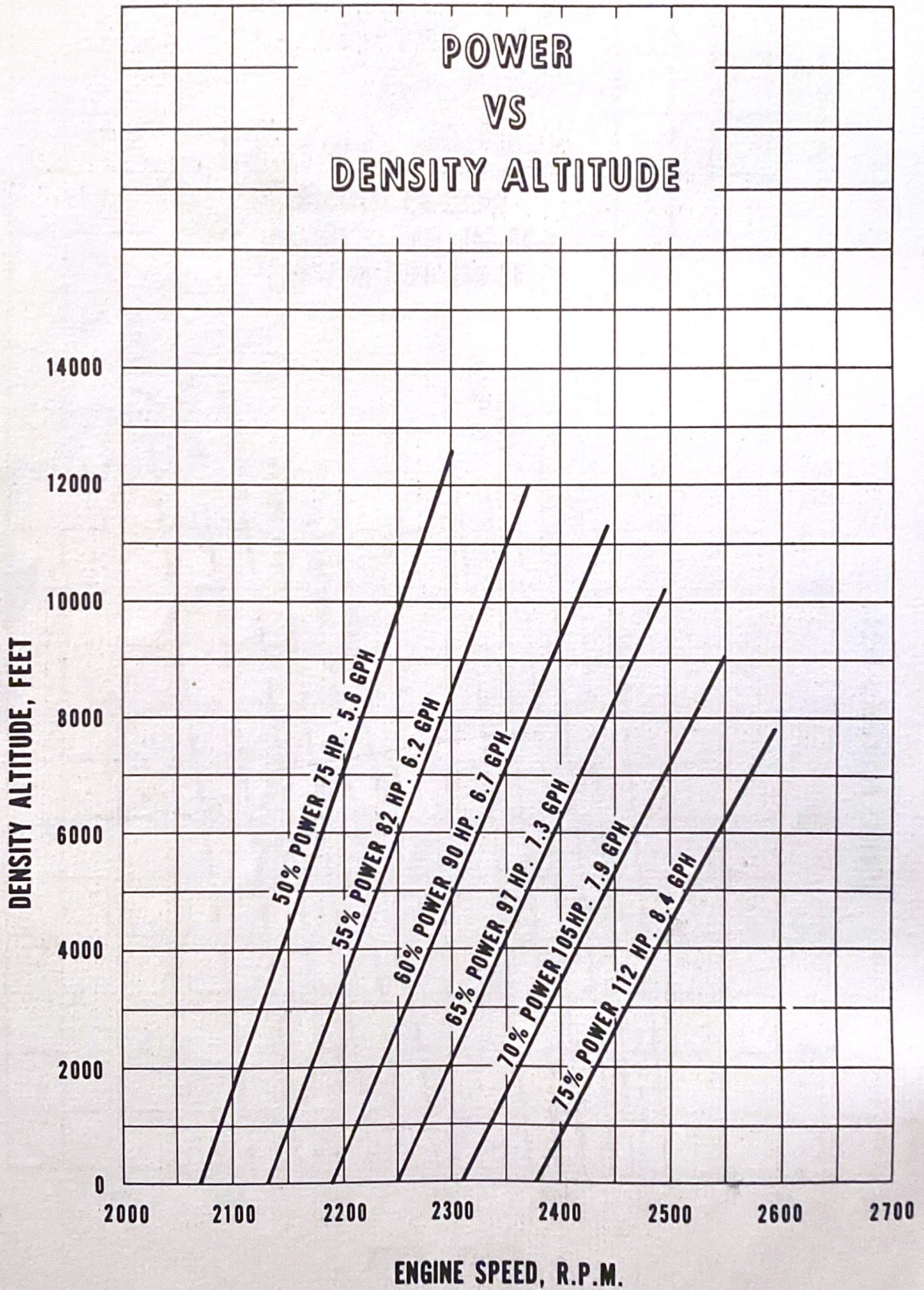



# PA-28-140 PIPER CHEROKEE

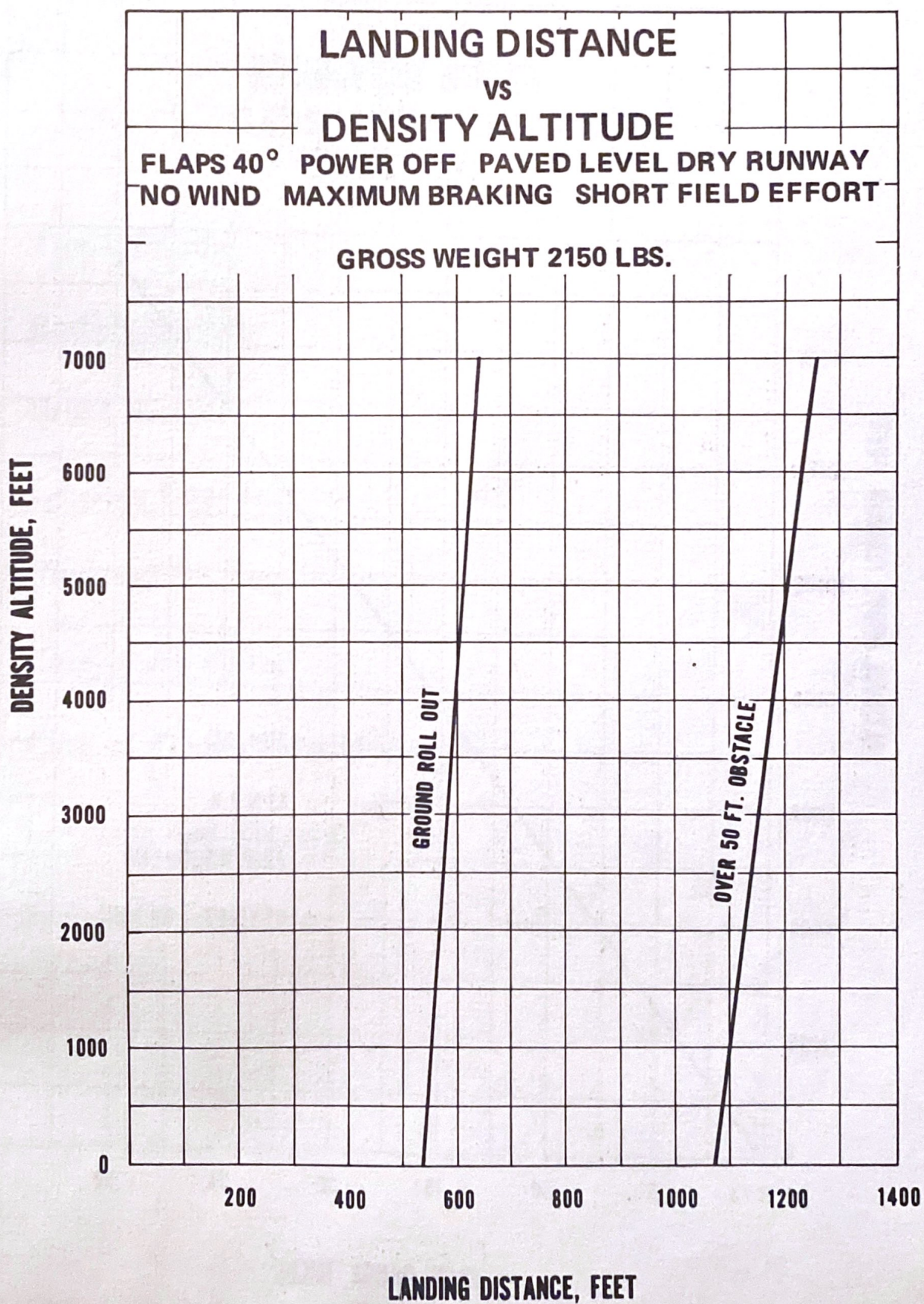



# PA-28-140 PIPER CHEROKEE

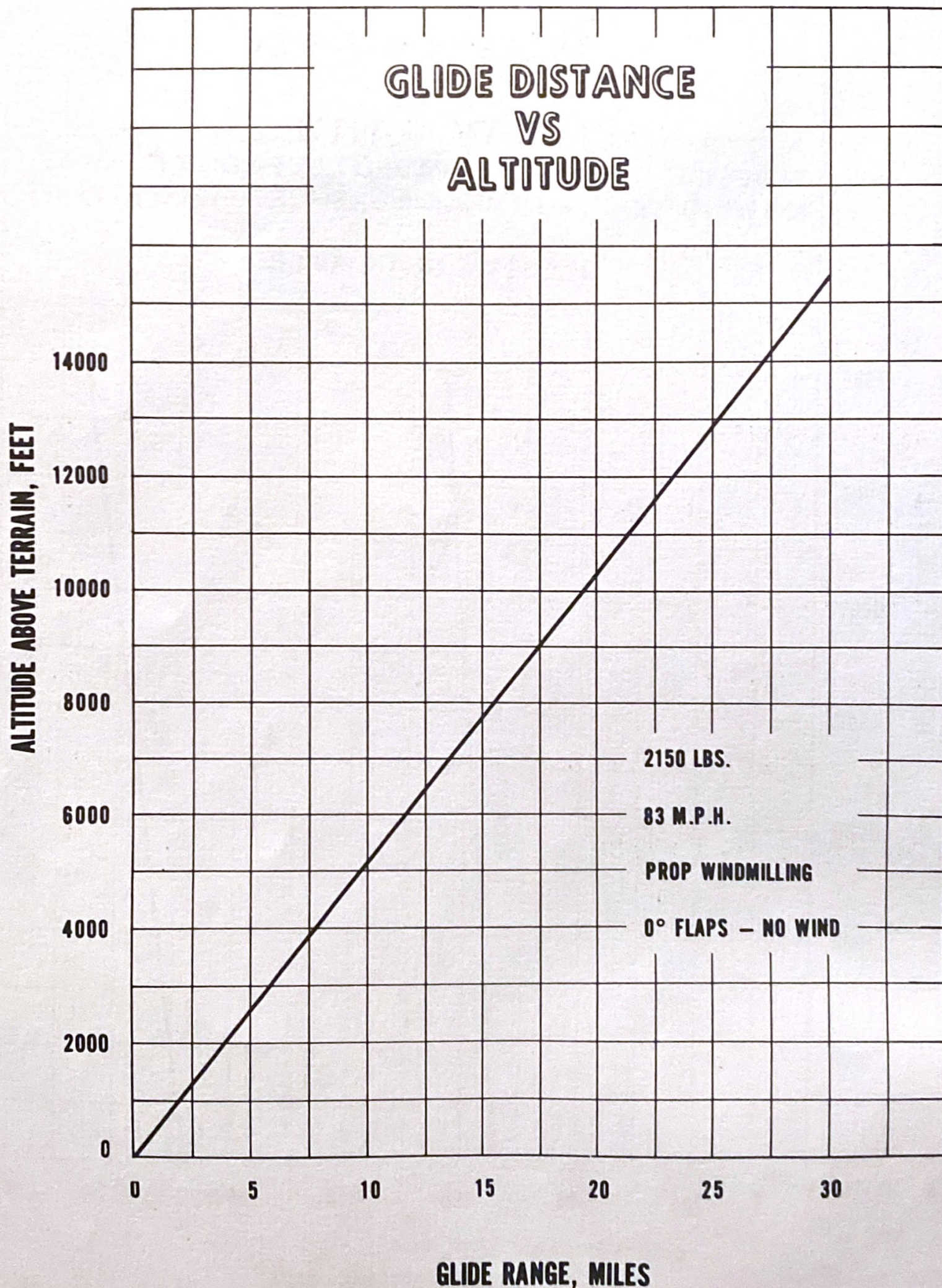



## SECTION V

### GENERAL MAINTENANCE

Tire Inflation . . . . .	36
Battery Service . . . . .	36
Brake Service . . . . .	37
Landing Gear Service . . . . .	37
Fuel and Oil Requirements . . . . .	41
Care of Air Filter . . . . .	42
Care of Windshield and Windows . . . . .	42
Leveling and Rigging . . . . .	43
Serial Number Plate . . . . .	44



## SECTION V

### GENERAL MAINTENANCE

This section contains information for minor maintenance of the airplane. For further maintenance assistance refer to the Cherokee 140 "B" Service Manual. Any complex repairs or modification should be accomplished by a Piper Certified Service Center or equivalent.

### TIRE INFLATION

For maximum service from the tires, inflate them to the proper pressure of 24 pounds for all three wheels. Interchange the tires on the main wheels, if necessary, to produce even wear. All wheels and tires are balanced before original installation, and the relationship of the tire, tube and wheel should be maintained, if at all possible. Out of balance wheels can cause extreme vibration on take-off. In the installation of new components, it may be necessary to rebalance the wheel with the tires mounted.

### BATTERY SERVICE

The 12 volt battery is located in a stainless steel container under the baggage compartment floor. This container should be drained occasionally by opening the rubber cap on the drain tube. Check the battery for proper fluid level (below the baffle plates) and use a hydrometer to determine the density of the battery fluid.

If the battery is discharged, charge it before take-off as three volts are needed to excite the alternator. To recharge, start at a 4 ampere rate and finish with a 2 ampere rate. Quick charges are not recommended.



## BRAKE SERVICE

The brake system is filled with MIL-H-5606 (petroleum base) hydraulic fluid. This should be checked at every 100 hour inspection and replenished when necessary by filling the brake reservoir on the firewall to the indicated level. If the system as a whole has to be refilled with fluid, this should be done by filling with the fluid under pressure from the brake end of the system. This will eliminate air from the system as it is being filled.

If after extended service the brake blocks become worn excessively, they are easily replaced with new segments. Brake clearances require no adjustments.



## LANDING GEAR SERVICE

Main wheels are easily removed by taking off the hub cap, axle nut, and the two bolts holding the brake segment in place, after which the wheel slips easily from the axle.

Tires are removed from the wheels by first deflating the tire, removing the three through bolts, and separating the wheel halves.

Landing gear oleo struts should be checked for proper strut exposures and fluid leaks. The required extensions for the strut when under normal static load (empty weight of airplane plus full fuel and oil) is 3.25 inches for the nose gear and 4.50 inches for the main gear. Should the strut exposure be below that required, it should be determined whether air or oil is required by first raising the airplane on jacks. Depress the valve core to allow air to escape from the strut housing chamber. Remove the filler plug and slowly raise the strut to full compression. If the strut has sufficient fluid it will be visible up to the bottom of the filler plug hole and will then only require proper inflation.

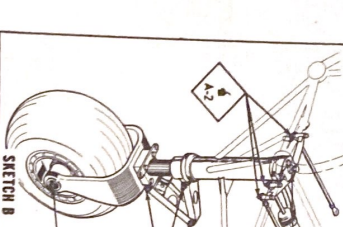
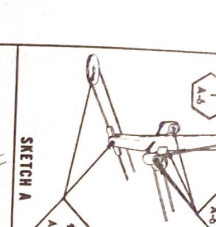
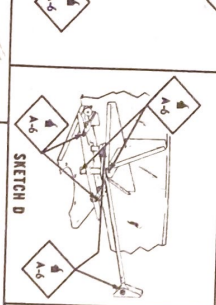
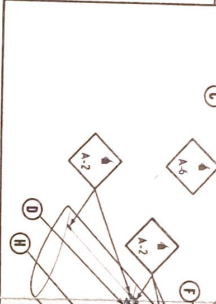
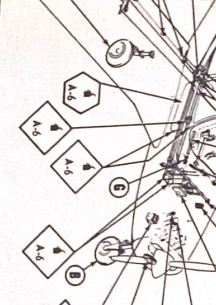
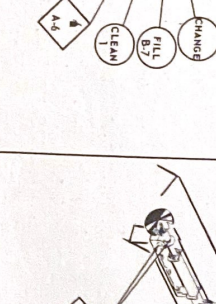
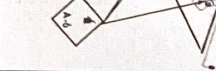
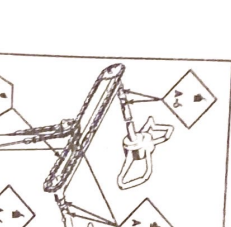
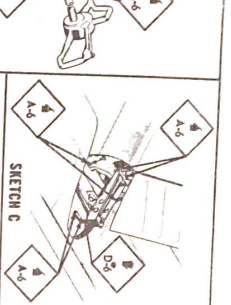
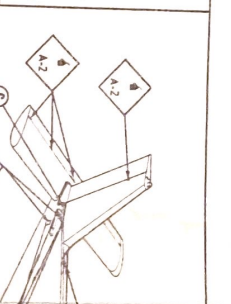
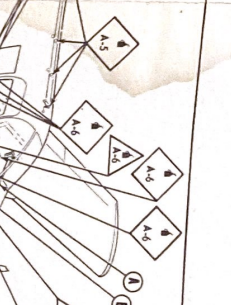
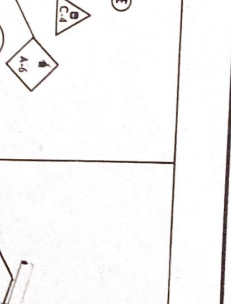

LUBRICATION CHART PA-28-140B	IDENTIFICATION LETTER	TYPE OF LUBRICANTS SPECIFICATION	SPECIAL INSTRUCTIONS	NOTES	
<p><b>EXAMPLE</b></p>  <p><b>SKETCH B</b></p>	<p><b>A</b></p> <p>MIL-L-7870</p> <p>LOW TEMPERATURE</p>	<p><b>B</b></p> <p>MIL-L-6082</p> <p>LUBRICATING OIL, AIRCRAFT RECIPROCATING ENGINE (PISTON) GRADE AS</p> <p>SAE 50 ABOVE 60° F AIR TEMP. SAE 40 30° TO 70° F AIR TEMP. SAE 30 0° TO 30° F AIR TEMP. SAE 20 BELOW 10° F AIR TEMP.</p>	<p>1. AIR FILTERS - TO CLEAN FILTER, TAP GENTLY TO REMOVE DIRT PARTICLES. DO NOT BLOW OUT WITH COMPRESSED AIR OR USE OIL. REPLACE FILTER IF PUNCTURED OR DAMAGED AND BEARINGS AND BUSHINGS - CLEAN EXTERIOR WITH A DRY TYPE WHEEL BEARING LUBRICATING OIL AND CLEAN WITH A DRY TYPE SOLVENT. ASSEMBLY THAT GREASE IS PACKED BETWEEN THE BEARING ROLLER AND CONE. DO NOT PACK GREASE IN WHEEL HOUSING.</p> <p>2. OIL STRUTS AND GRAZE RESERVOIR - FILL PER INSTRUCTION MANUAL.</p> <p>3. OVERHEAD TRIM PULLEYS - LUBRICATION MAY BE EXTENDED TO 250 HOURS WHEN DUSTY CONDITIONS ARE AT A MINIMUM.</p> <p>4. LUBRICATION POINTS - WIPE ALL LUBRICATION POINTS CLEAN BEFORE GREASE, OIL, DIRT, ETC. BEFORE LUBRICATING.</p> <p>5. IN SERVICIALS BETWEEN OIL FILLS, EQUIPPED WITH FILL FLOW CARTRIDGE TYPE OIL FILTERS - PROVIDED THE ELEMENT IS REPLACED EACH 50 HOURS OF OPERATION.</p>	<p>1. PILOT AND PASSENGER SEATS - LUBRICATE TRACK ROLLERS</p> <p>2. WHEEL BEARINGS REQUIRE CLEANING AND REPACKING AFTER EXPOSURE TO AN ABNORMAL QUANTITY OF WATER.</p> <p>3. FUEL SELECTOR VALVE - LUBRICATE FUEL SELECTOR VALVE AS REQUIRED. REFER TO PIPER SERVICE LETTER NO. 351.</p> <p>4. SEE WHEEL BEARING SERVICE INSTRUCTIONS NO. 1014 FOR USE OF DETERGENT OIL.</p>	
 <p><b>SKETCH A</b></p>	 <p><b>SKETCH C</b></p>	 <p><b>SKETCH D</b></p>	 <p><b>SKETCH E</b></p>	 <p><b>SKETCH F</b></p>	 <p><b>SKETCH G</b></p>
 <p><b>SKETCH H</b></p>	 <p><b>SKETCH I</b></p>	 <p><b>SKETCH J</b></p>	 <p><b>SKETCH K</b></p>	 <p><b>SKETCH L</b></p>	 <p><b>SKETCH M</b></p>



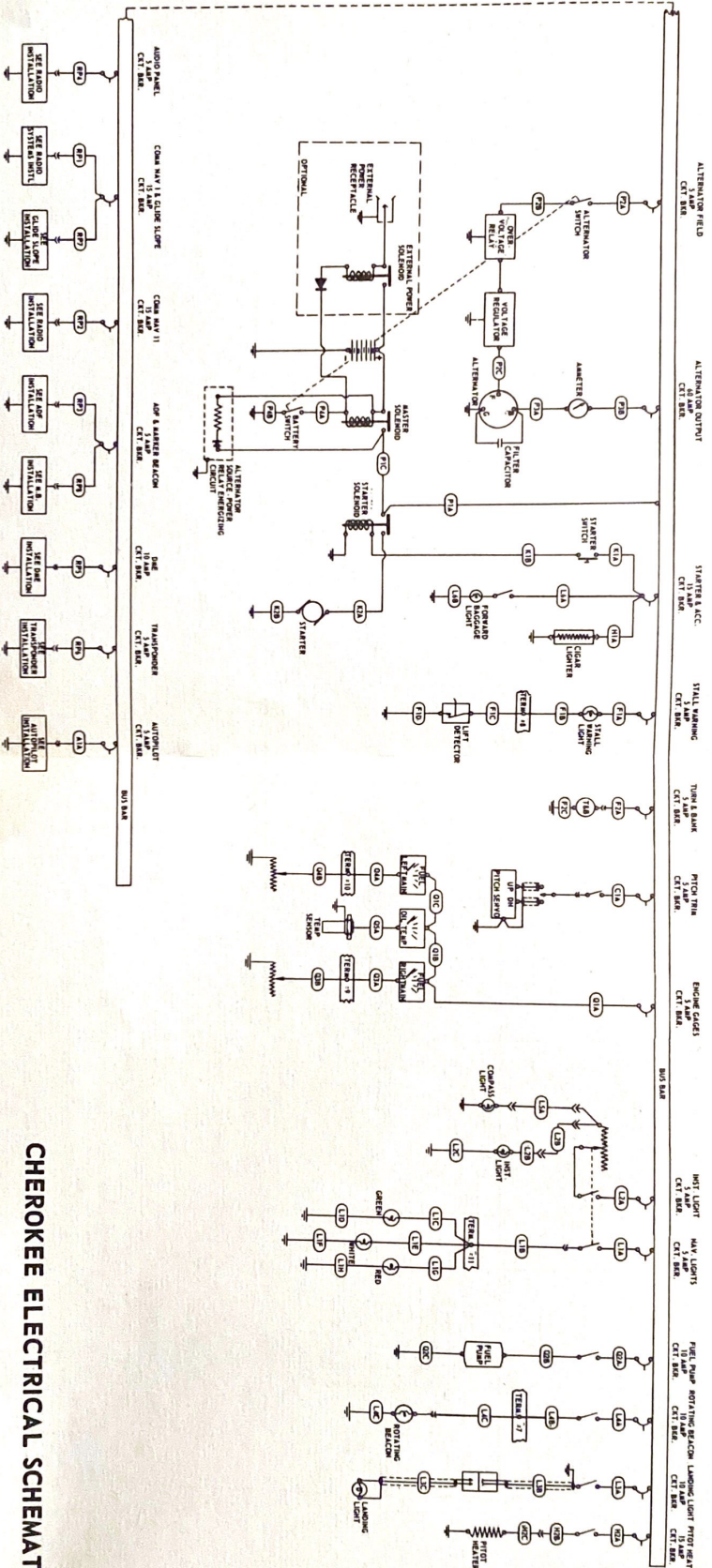

CHEROKEE ELECTRICAL SCHEMATIC



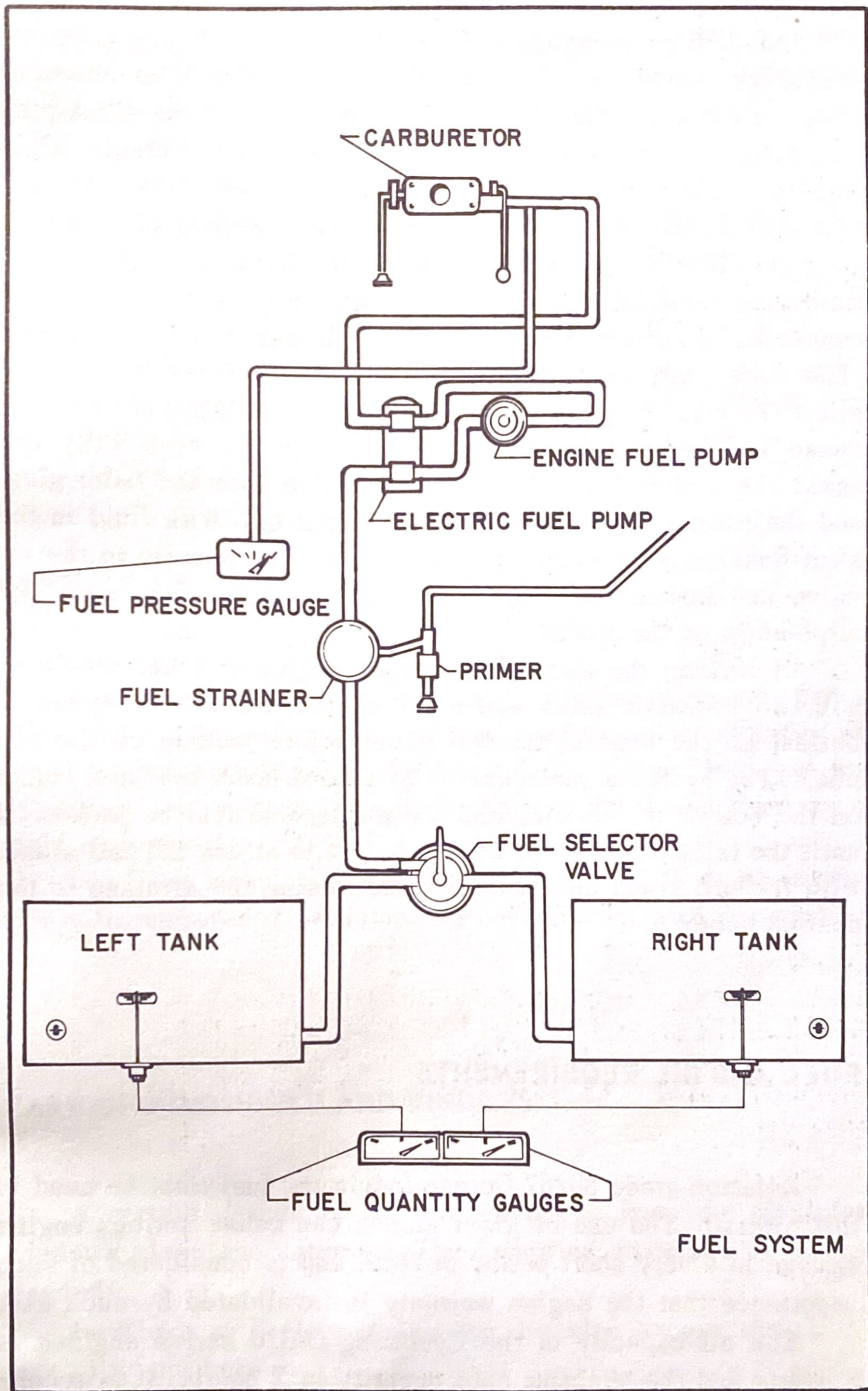



Should fluid be below the bottom of the filler plug hole, oil should be added. Replace the plug with valve core removed, attach a clear plastic hose to the valve stem of the filler plug and submerge the other end in a container of hydraulic fluid (MIL-H-5606). Fully compress and extend the strut several times thus drawing fluid from the container and expelling air from the strut chamber. To allow fluid to enter the bottom chamber of the main gear strut housing, the torque link assembly must be disconnected to let the strut be extended a minimum of 10 inches. (The nose gear torque links need not be disconnected.) Do not allow the strut to extend more than 12 inches. When air bubbles cease to flow through the hose, compress the strut fully and again check fluid level. Reinstall the valve core and filler plug, and the main gear torque links if disconnected. With fluid in the strut housing at the correct level, attach a strut pump to the air valve and inflate the oleo strut to the correct height when the airplane is on the ground.

In jacking the airplane for landing gear or other servicing use two hydraulic jacks and a tail stand. Place 350 pounds of ballast on the base of the tail stand before jacking up the airplane. The hydraulic jacks should be placed under the jack points on the bottom of the wing and the airplane should be jacked up until the tailskid is at the correct height to attach the tail stand. With the tail stand attached continue raising the airplane to the desired height.

## FUEL AND OIL REQUIREMENTS

Aviation grade 80/87 Octane (minimum) fuel must be used in this aircraft. The use of lower grades can cause serious engine damage in a very short period of time, and is considered of such importance that the engine warranty is invalidated by such use.

The oil capacity of the Lycoming O-320 series engines is 8 quarts and the minimum safe quantity is 2 quarts. It is recom-



mended that the oil be changed every 50 hours or sooner under unfavorable conditions. The following grades are recommended for the specified temperatures:

<u>Average Ambient Air Temperature For Starting</u>	<u>Single Viscosity Grade</u>	<u>Multi-Viscosity Grades</u>
Above 60° F	SAE 50	SAE 40 or SAE 50
30° to 90° F	SAE 40	SAE 40
0° to 70° F	SAE 30	SAE 40 or 20W-30
Below 10° F	SAE 20	SAE 20W-30

**CARE OF AIR FILTER**

The carburetor air filter must be cleaned at least once every 50 hours. Under extremely adverse conditions of operation it may be necessary to clean the filter daily. Extra filters are inexpensive and a spare should be kept on hand and used as a rapid replacement.

The filter manufacturer recommends that the filter be tapped gently to remove dirt particles. Do not blow out with compressed air.

**CARE OF WINDSHIELD AND WINDOWS**

A certain amount of care is needed to keep the plexiglas windows clean and unmarred. The following procedure is recommended:

1. Flush with clean water and dislodge excess dirt, mud, etc. with your hand.



2. Wash with mild soap and water. Use a soft cloth or sponge, do not rub.

3. Remove oil, grease or sealing compounds with a soft cloth and kerosene.

4. After cleaning, apply a thin coat of hard polishing wax. Rub lightly with a soft cloth.

5. A severe scratch or mar may be removed by using jeweler's rouge to rub out the scratch, smoothing, and then applying wax.

## LEVELING AND RIGGING

Leveling the aircraft for purposes of weighing or rigging is accomplished as follows:

1. Partially withdraw two machine screws located immediately below the left front side window. These screws are leveling points and the airplane is longitudinally level when a level placed on the heads of these screws indicates level.

2. To put the airplane in a longitudinally level position on scales, first block the main gear oleos in the fully extended position, then deflate the nose wheel tire until the proper attitude is obtained. For rigging only, the airplane may be placed on jacks for leveling.

3. To level the airplane laterally, place a level across the baggage compartment floor along the rear bulkhead.

Rigging: Although the fixed flight surfaces cannot be adjusted for rigging purposes, it may be necessary upon occasion to check the position of these surfaces. The movable surfaces all have adjustable stops, as well as adjustable turnbuckles on the cables or push-pull tubes, so that their range of travel can be altered. The positions and angular travels of the various surfaces are as follows:

1. Wings: 7° dihedral, 2° washout.

2. Stabilator Travel: 18° up, 2° down, tolerance  $\pm 1^\circ$ .



3. Fin should be vertical and in line with center of fuselage.
4. Aileron Travel: 30° up, 15° down, tolerance  $\pm 2^\circ$ .
5. Flap Travel: 10°, 25°, 40°, tolerance  $\pm 2^\circ$ .
6. Rudder Travel: 27° right and left, tolerance  $\pm 2^\circ$ .
7. Stabilator Tab Travel: 3° up, 12° down, tolerance  $\pm 1^\circ$ .

Cable tensions for the various controls are as follows:

Rudder: 40  $\pm$ 5 lbs.

Stabilator: 40  $\pm$ 5 lbs.

Ailerons: 40  $\pm$ 5 lbs.

Stabilator Trim: 10  $\pm$ 1 lb.

Flaps: 10  $\pm$ 1 lb.

### SERIAL NUMBER PLATE

The serial number plate is located near the stabilator on the left side of the airplane and also at the cabin entrance. Refer to this number for service or warranty matters.



# INDEX

<b>SECTION I</b>	<b>Page</b>
Specifications: . . . . .	1
Performance . . . . .	1
Weights . . . . .	2
Power Plant . . . . .	2
Fuel and Oil . . . . .	3
Baggage . . . . .	3
Dimensions . . . . .	3
Landing Gear . . . . .	4
 <b>SECTION II</b>	
Design Information: . . . . .	6
Engine and Propeller . . . . .	6
Structures . . . . .	7
Landing Gear. . . . .	7
Control System . . . . .	8
Fuel System . . . . .	9
Electrical System . . . . .	9
Heating and Ventilating System. . . . .	11
Cabin Features . . . . .	13
 <b>SECTION III</b>	
Operating Instructions: . . . . .	15
Preflight . . . . .	15
Starting Engine . . . . .	16
Warm-Up . . . . .	18
Ground Check . . . . .	19
Take-Off . . . . .	19
Climb . . . . .	21
Stalls . . . . .	21
Cruising . . . . .	22



## INDEX (cont)

<b>SECTION III (cont)</b>	<b>Page</b>
Maneuvers . . . . .	23
Approach and Landing . . . . .	23
Stopping Engine . . . . .	24
Engine Power Loss. . . . .	24
Mooring . . . . .	25
Weight and Balance . . . . .	25
Operating Tips . . . . .	25
 <b>SECTION IV</b>	
Performance Charts: . . . . .	28
Altitude Conversion Chart . . . . .	28
Take-off Distance vs Density Altitude . . . . .	29
Rate of Climb vs Density Altitude . . . . .	30
True Airspeed vs Density Altitude . . . . .	31
Range vs Density Altitude . . . . .	32
Power vs Density Altitude . . . . .	33
Landing Distance vs Density Altitude . . . . .	34
Glide Distance vs Attitude . . . . .	35
 <b>SECTION V</b>	
General Maintenance: . . . . .	36
Tire Inflation. . . . .	36
Battery Service . . . . .	36
Brake Service . . . . .	37
Landing Gear Service . . . . .	37
Fuel and Oil Requirements . . . . .	41
Care of Air Filter . . . . .	42
Care of Windshield and Windows . . . . .	42
Leveling and Rigging . . . . .	43
Serial Number Plate . . . . .	44